

WAAS CH 77628 W12A	APP CRS 120°	Rwy Idg 2990 TDZE 37 Apt Elev 38
---------------------------------	------------------------	---

RNAV (GPS) RWY 12

BREVIG MISSION (KTS) (PFKT)

RNP APCH.	<p>⚠ Circling NA north of Rws 12 and 23. Circling Rwy 23 NA at night. For uncompensated Baro-VNAV systems, LNAV/VNAV NA below -25° C or above 54°C.</p>	<p>MISSED APPROACH: Climb to 6300 direct CUSEW and hold, continue climb-in-hold to 6300.</p>
-----------	--	--

AWOS-3P 121.55	ANCHORAGE CENTER 133.3 290.4	NOME RADIO 135.6	CTAF 123.0
--------------------------	--	----------------------------	----------------------

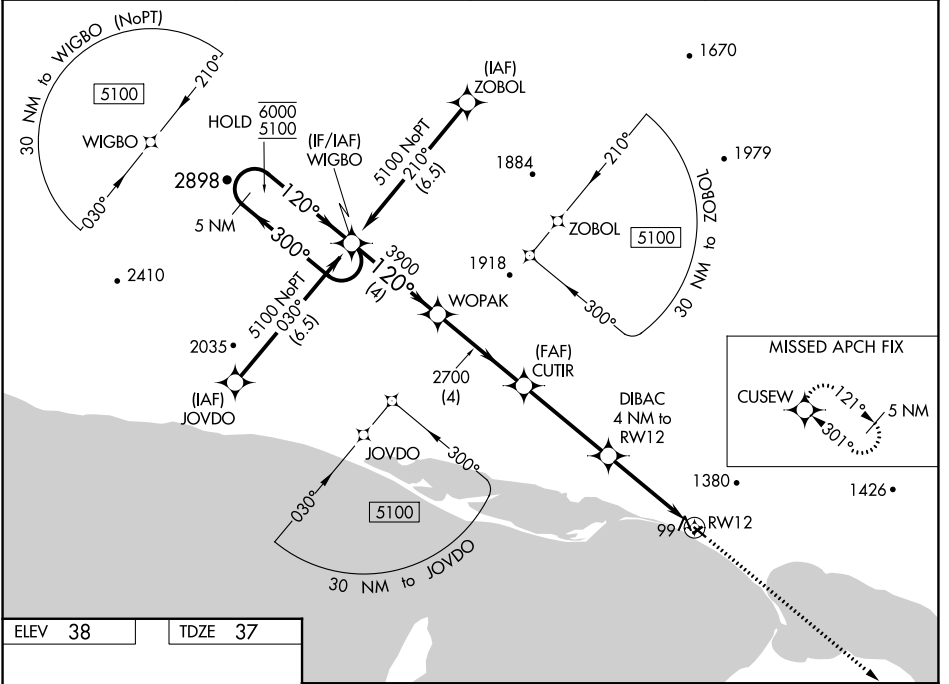

ELEV 38	TDZE 37
---------	---------

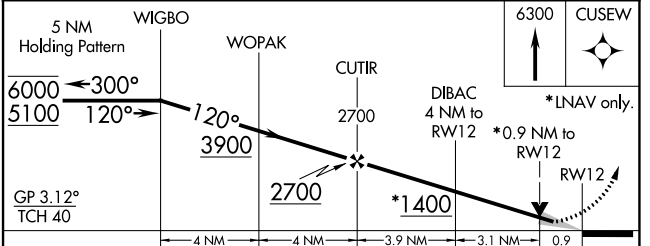
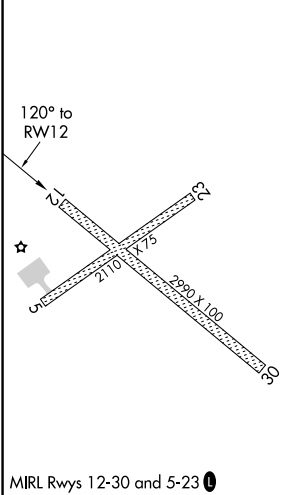

CATEGORY	A	B	C	D
LPV DA	287-1	250 (300-1)		NA
LNAV/VNAV DA	287-1	250 (300-1)		NA
LNAV MDA	360-1	323 (400-1)		NA
C CIRCLING	620-1 582 (600-1)	1460-1½ 1422 (1500-1½)		NA

AK, 25 JAN 2024 to 21 MAR 2024

AK, 25 JAN 2024 to 21 MAR 2024

WAAS CH 81928 W30A	APP CRS 301°	Rwy Idg 2990 TDZE 37 Apt Elev 38
--	------------------------	---

RNAV (GPS) RWY 30

BREVIG MISSION (KTS) (PFKT)

RNP APCH.

⚠ Circling NA north of Rwy 12 and 23. Circling Rwy 23 NA at night.
⚠ For uncompensated Baro-VNAV systems, LNAV/VNAV NA below -25° C or above 54°C.

MISSED APPROACH: Climb to 5100 direct WIGBO and hold, continue climb-in-hold to 5100.

AWOS-3P 121.55	ANCHORAGE CENTER 133.3 290.4	NOME RADIO 135.6	CTAF 123.0
--------------------------	--	----------------------------	----------------------

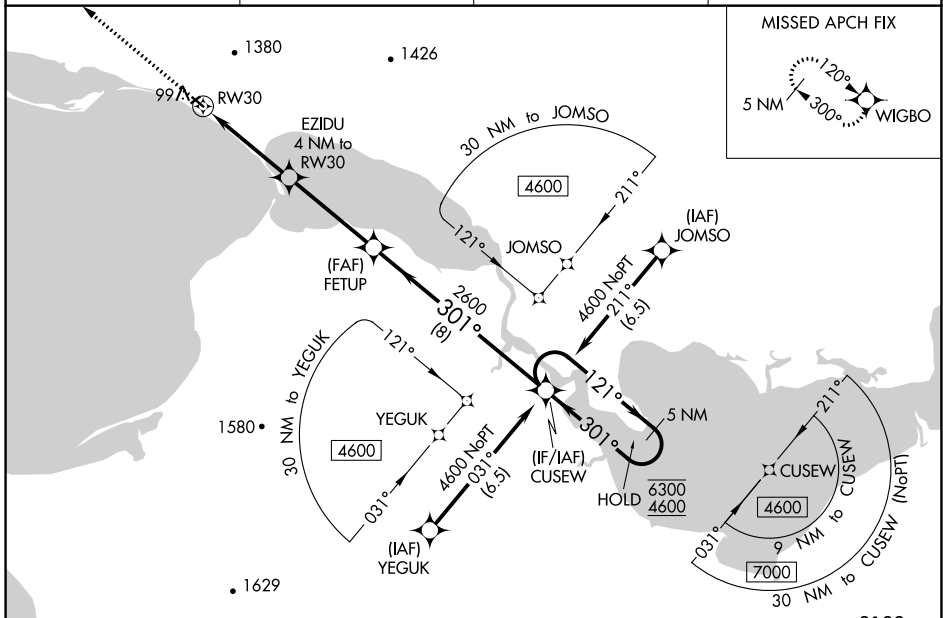

ELEV 38	TDZE 37
---------	---------

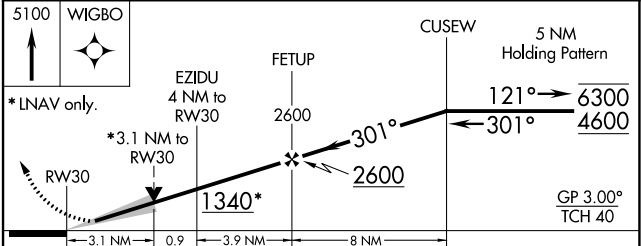
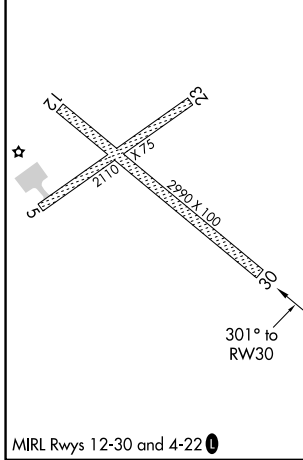

CATEGORY	A	B	C	D
LPV DA	287-1¼ 250 (300-1¼)	287-1	250 (300-1)	NA
LNAV/VNAV DA	960-4 923 (1000-4)			NA
LNAV MDA	1080-1¼ 1043 (1100-1¼)	1080-1½ 1043 (1100-1½)	1080-3 1043 (1100-3)	NA
C CIRCLING	1080-1¼ 1042 (1100-1¼)	1460-2½ 1422 (1500-2½)	1580-3 1542 (1600-3)	NA

AK, 25 JAN 2024 to 21 MAR 2024

AK, 25 JAN 2024 to 21 MAR 2024

INSTRUMENT APPROACH PROCEDURE CHARTS

IFR ALTERNATE AIRPORT MINIMUMS

Pilots must review the IFR Alternate Minimums Notes to determine alternate airport suitability.

△NA designation on the approach chart means that pilots may not use that approach as an alternate due to unmonitored facility, absence of weather reporting service, or lack of adequate navigation coverage. Approaches with the **△**NA designation are not listed in this section. **△** designation on the approach chart indicates that the approach procedure has non-standard minimums (for aircraft other than helicopters) or restrictions (for all users) for its use as an alternate.

Alternate Minima (ref: 14 CFR 91.169)

	Precision Approach	Non-Precision Approach
Standard	600-2	800-2
△ Non-Standard or restrictions	As indicated below	As indicated below
Helicopters	For the selected approach: Ceiling: 200' above published ceiling Visibility: the greater of 1 SM visibility or the published visibility	
US Military (USA/USN/USAF)	See Service Regulations	

Note: For alternate airport flight planning purposes, precision approach operations include: ILS, PAR, and GLS, and Non-Precision approach operations include: NDB, VOR, LOC, TACAN, LDA, SDF, ASR, RNAV (GPS) and RNAV (RNP).

NAME ALTERNATE MINIMUMS

ADAK ISLAND, AK

ADAK (ADK) (PADK).....**ILS Y or LOC Y Rwy 23¹**
ILS Z or LOC Z Rwy 23²
NDB/DME Rwy 23³⁴⁵
RNAV (GPS) Rwy 23⁵⁶
TACAN Rwy 23⁷

- ¹ILS, Categories A, B, C, D, E, 1600-5; LOC, Category A, B, 1500-2; Category C, 1500-3; Category D, 2400-3; Category E, 2500-3.
- ²LOC, Category C, 1100-3; Category D, 2400-3; Category E, 2500-3.
- ³Categories A, B, 1600-2; Category C, 1600-3; Category D, 2600-3.
- ⁴NA when control tower closed.
- ⁵NA when local weather not available.
- ⁶Categories A, B, C, 1300-3.
- ⁷Categories A, B, 1700-2; Category C, 1700-3; Category D, 2500-3; Category E, 2600-3.

AKHIOK, AK

AKHIOK (AKK) (PAKH).....**RNAV (GPS)-A**
 Category B, 1400-2.

NAME ALTERNATE MINIMUMS

AKUTAN, AK

ATUKAN (7AK) (PAUT).....**RNAV (GPS)-A¹²**
RNAV (GPS) Rwy 9²
RNAV (GPS) Rwy 27²

- ¹NA when local weather not available.
- ²Category A, 900-2; Category B, 1100-2; Category C, 1500-3; Category D, 1900-3.
- ³Category A, 1100-2; Category B, 1100-2; Category C, 1500-3; Category D, 1900-3.

ALLEN AAF (PABI)

DELTA JUNCTION/
 FORT GREELY, AK.....**Orig B 08325**
ILS or LOC/DME Rwy 10

NA when control tower closed.

AMBLER, AK

AMBLER (AFM) (PAFM).....**RNAV (GPS) Rwy 1**
 Category D, 800-2¼.

ANAKTUVUK PASS, AK

ANAKTUVUK
 PASS (AKP) (PAKP).....**RNAV (GPS)-A**
 Categories A, B, 3600-2; Categories C, D, 4200-3.

25 JAN 2024 to 21 MAR 2024

25 JAN 2024 to 21 MAR 2024

NAME ALTERNATE MINIMUMS

ANCHORAGE, AK

MERRILL FLD (MRI) (PAMR).....RNAV (GPS)-A
NA when local weather not available.
Category C, 800-2¼.

TED STEVENS ANCHORAGE

INTL (ANC) (PANC).....ILS or LOC Rwy 7L¹
ILS or LOC Rwy 7R¹
RNAV (GPS) Rwy 7L²³
RNAV (GPS) Rwy 15³
RNAV (GPS) Y Rwy 7R²³

¹LOC, Category D, 800-2¼; Category E, 800-2¾.

²NA when local weather not available.

³Category D, 800-2¼.

ANIAK, AK

ANIAK (ANI) (PANI).....ILS or LOC Rwy 11¹²
RNAV (GPS) Rwy 11³⁴
RNAV (GPS) Rwy 29³⁵

¹LOC, NA when local weather not available.

²LOC, Category C, 800-2¼; Category D, 1200-3.

³NA when local weather not available.

⁴Categories A, B, C, 900-4; Category D, 1200-4.

⁵Category C, 800-2¼; Category D, 1200-3.

ANVIK, AK

ANVIK (ANV) (PANV).....RNAV (GPS) Rwy 17
RNAV (GPS) Rwy 35
NA when local weather not available.

ATKA, AK

ATKA (AKA) (PAAK).....RNAV (GPS)-A
Categories A, B, 1300-2; Category C, 1900-3.
NA when local weather not available.

ATQASUK, AK

ATQASUK EDWARD BURNELL SR
MEML (ATK) (PATQ).....RNAV (GPS) Rwy 7
RNAV (GPS) Rwy 25
NA when local weather not available.

BETHEL, AK

BETHEL
(BET) (PABE).....ILS Y or LOC Y Rwy 19R¹
ILS Z or LOC Z Rwy 19R¹
RNAV (GPS) Rwy 1R
VOR Rwy 1L

NA when local weather not available.

¹NA when control tower closed.

BETTLES, AK

BETTLES (BTT) (PABT).....RNAV (GPS) Rwy 2
RNAV (GPS) Rwy 20
VOR Rwy 2
Category D, 800-2¼.

NAME ALTERNATE MINIMUMS

BREVIG MISSION, AK

BREVIG
MISSION (KTS) (PFKT).....RNAV (GPS) Rwy 12¹²
RNAV (GPS) Rwy 30³

¹NA when local weather not available.

²Category B, 1500-2.

³Category A, 1100-4; Category B, 1500-4;

Category C, 1800-4.

BUCKLAND, AK

BUCKLAND (BVK) (PABL).....RNAV (GPS) Rwy 11
RNAV (GPS) Rwy 29
NA when local weather not available.

CHEVAK, AK

CHEVAK (VAK) (PAVA).....RNAV (GPS) Rwy 2
RNAV (GPS) Rwy 20
NA when local weather not available.

CLARKS POINT, AK

CLARKS POINT
(CLP) (PFCL).....RNAV (GPS) Rwy 36
NA when local weather not available.

COLD BAY, AK

COLD BAY (CDB) (PACD).....ILS or LOC Rwy 15¹
LOC BC Rwy 33²
RNAV (GPS) Rwy 15²
RNAV (GPS) Rwy 26²
RNAV (GPS) Rwy 33²
VOR Rwy 15²

¹LOC, Category D, 800-2¼.

²Category D, 800-2¼.

CORDOVA, AK

MERLE K (MUDHOLE)
SMITH (CDV) (PACV).....ILS or LOC Rwy 27¹
RNAV (GPS) Rwy 27²
RNAV (GPS)-B²

NA when local weather not available.

¹LOC, Category D, 1500-3.

²Category D, 1500-3.

DEADHORSE, AK

DEADHORSE (SCC) (PASC).....ILS or LOC Rwy 6
LOC BC Rwy 24
RNAV (GPS) Z Rwy 6
NA when local weather not available.

DEERING, AK

DEERING (DEE) (PADE).....RNAV (GPS) Rwy 3¹
RNAV (GPS) Rwy 12²
RNAV (GPS) Rwy 21¹
RNAV (GPS) Rwy 30¹

¹Category B, 900-2; Category C, 900-2¼.

²Category B, 900-2; Category C, 900-2¼.

25 JAN 2024 to 21 MAR 2024

25 JAN 2024 to 21 MAR 2024

NAME ALTERNATE MINIMUMS

DILLINGHAM, AK

DILLINGHAM (DLG) (PADL).....LOC Rwy 19¹
RNAV (GPS) Rwy 1¹
RNAV (GPS) Rwy 19¹
VOR Rwy 1

Category D, 800-2¼.

¹NA when local weather not available.

EAGLE, AK

EAGLE (EAA) (PAEG).....RNAV (GPS)-A
NA when local weather not available.
Categories A, B, 1900-2; Category C, 2200-3.

ELIM, AK

ELIM (ELI) (PFEL).....RNAV (GPS) Rwy 1¹
RNAV (GPS)-A²

¹Categories A, B, 900-2; Category C, 900-2½;

Category D, 900-2¼.

²Category B, 900-2.

EMMONAK, AK

EMMONAK (ENM) (PAEM)....RNAV (GPS) Rwy 16
RNAV (GPS) Rwy 34
VOR Rwy 16

NA when local weather not available.

FAIRBANKS, AK

FAIRBANKS
INTL (FAI) (PAFA).....ILS or LOC Rwy 2L¹
ILS Z or LOC Z Rwy 20R¹
TACAN Rwy 20R²

¹LOC, Category E, 800-2¼.

²Category E, 800-2½.

GALENA, AK

EDWARD G PITKA SR
(GAL) (PAGA).....VOR Rwy 26
NA when local weather not available.

GAMBELL, AK

GAMBELL (GAM) (PAGM).....NDB/DME Rwy 34¹
NDB Rwy 16²
RNAV (GPS) Rwy 16³
RNAV (GPS) Rwy 34³

¹Categories A, B, 900-2; Category C, 900-2½;

Category D, 900-2¼.

²Categories A, B, 1000-2; Categories C, D, 1000-3.

³NA when local weather not available.

GOLOVIN, AK

GOLOVIN (GLV) (PAGL).....RNAV (GPS) Rwy 3
RNAV (GPS)-A

Category D, 1000-3

NAME ALTERNATE MINIMUMS

GUSTAVUS, AK

GUSTAVUS
(GST) (PAGS).....RNAV (GPS) Rwy 29¹²
VOR/DME Rwy 29³

¹Category C, 1000-2¼; Category D, 1200-3.

²NA when local weather not available.

³Categories A, B, 1300-2; Categories C, D, 1300-3.

HOLY CROSS, AK

HOLY
CROSS (HCA) (PAHC).....RNAV (GPS) Rwy 1¹
RNAV (GPS) Rwy 19²

NA when local weather not available.

¹Categories A, B, 900-2; Category C, 900-2½;

Category D, 900-2¼.

²Categories A, B, 1000-2; Category C, 1000-2¼;

Category D, 1000-3.

HOMER, AK

HOMER (HOM) (PAHO).....LOC Rwy 4
RNAV (GPS) Y Rwy 4
RNAV (GPS) Y Rwy 22

Category D, 800-2¼.

HOOPER BAY, AK

HOOPER BAY (HPB) (PAHP)...RNAV (GPS) Rwy 14
RNAV (GPS) Rwy 32
VOR Rwy 32

NA when local weather not available.

IGIUGIG, AK

IGIUGIG (IGG) (PAIG).....RNAV (GPS) Rwy 5
RNAV (GPS) Rwy 23

NA when local weather not available.

ILIAMNA, AK

ILIAMNA (ILI) (PAIL).....NDB Rwy 36
RNAV (GPS) Rwy 8
RNAV (GPS) Rwy 18¹
RNAV (GPS) Rwy 26
RNAV (GPS) Rwy 36

Category D, 1600-3

¹NA when local weather not available.

JUNEAU, AK

JUNEAU INTL (JNU) (PAJN).....LDA X Rwy 8¹²
RNAV (GPS) V Rwy 8³

NA when local weather not available.

¹NA when control tower closed.

²Categories A, B, 3200-4; Category C, 3400-4;

Category D, 3700-4.

³Categories A, B, 2400-3.

25 JAN 2024 to 21 MAR 2024

25 JAN 2024 to 21 MAR 2024

NAME ALTERNATE MINIMUMS

KAKE, AKKAKE (AFE) (PAFE).....**NDB/DME Rwy 11¹**
RNAV (GPS) Rwy 11²

NA when local weather not available.

¹Categories A, B, 1000-2; Category C, 1000-2½.²Categories A, B, 1000-2; Category C, 1000-3.**KALSKAG, AK**KALSKAG (KLG) (PALG).....**RNAV (GPS)-A**
RNAV (GPS) Rwy 7

NA when local weather not available.

KALTAG, AKKALTAG (KAL) (PAKV).....**RNAV (GPS) Rwy 3¹**
RNAV (GPS) Rwy 21^{2,3}¹Category A, 1100-2; Categories B, C, 1100-3.²Category C, 1100-3.³NA when local weather not available.**KENAI, AK**KENAI MUNI
(ENA) (PAEN).....**ILS Y or LOC Y Rwy 20R¹**
RNAV (GPS) Rwy 2L²
RNAV (GPS) Rwy 20R²
VOR Rwy 2L²
VOR Rwy 20R²¹LOC, Category E, 800-2¼;²NA when local weather not available.**KETCHIKAN, AK**KETCHIKAN
INTL (KTN) (PAKT).....**ILS Y or LOC Y Rwy 11¹**
ILS Z or LOC Z Rwy 11¹
LOC X Rwy 11²
RNAV (GPS)-B³¹LOC, Categories C, D, 800-2¼.²Category A, 2100-2; Category B, 2600-2;
Category C, 3000-3; Category D, 3300-3.³Category A, 1900-2; Category B, 2600-2;
Categories C, D, 2800-3.**KING COVE, AK**KING COVE (KVC) (PAVC).....**RNAV (GPS)-A**
NA when local weather not available.

Category A, 2000-6; Category B, 2400-6.

KING SALMON, AKKING SALMON
(AKN) (PAKN).....**ILS Y or LOC Y Rwy 12¹**
LOC BC Rwy 30^{1,2}
RNAV (GPS) Rwy 12²
RNAV (GPS) Rwy 30²
VOR Y or TACAN Y Rwy 12²
VOR Y or TACAN Y Rwy 30²¹NA when control tower closed.²Category D, 900-2¼; Category E, 900-3.

NAME ALTERNATE MINIMUMS

KIPNUK, AKKIPNUK (LIK) (PAKI).....**RNAV (GPS) Rwy 17**
RNAV (GPS) Rwy 35

NA when local weather not available.

KIVALINA, AKKIVALINA (KVL) (PAVL).....**RNAV (GPS) Rwy 12**
RNAV (GPS) Rwy 30

NA when local weather not available.

KLAWOCK, AKKLAWOCK (AKW) (PAKW)....**RNAV (GPS) Rwy 20¹**
RNAV (GPS) Y Rwy 2²

NA when local weather not available.

¹Categories A, B, 2300-2.²Categories A, B, 1200-2, Category C, 1300-3.**KODIAK, AK**KODIAK (ADQ) (PADQ)....**ILS Y or LOC Y Rwy 26¹**
RNAV (GPS) Rwy 26²
VOR Rwy 26³¹ILS, Categories A, B, C, 700-3; Category D, 800-3;
LOC, Categories A, B, 800-2¼; Categories C, D, 1100-3.²Categories A, B, 900-2; Category C, 1000-2¼;
Category D, 2000-3.³Category C, 1100-3.**KOLIGANEK, AK**KOLIGANEK (JZZ) (PAJZ).....**RNAV (GPS) Rwy 9**
RNAV (GPS) Rwy 27

NA when local weather not available.

KOTZEBUE, AKRALPH WIEN
MEML (OTZ) (PAOT).....**ILS or LOC Rwy 9¹**
RNAV (GPS) Rwy 9²
RNAV (GPS) Rwy 27²
VOR Rwy 9²
VOR Rwy 27²¹LOC, Category D, 800-2¼.²Category D, 800-2¼.**MANOKOTAK, AK**MANOKOTAK
(MBA) (PAMB).....**RNAV (GPS) Rwy 3**
RNAV (GPS) Rwy 21

NA when local weather not available.

MARSHALL, AKMARSHALL DON HUNTER SR
(MDM) (PADM).....**RNAV (GPS) Rwy 7¹**
RNAV (GPS)-A²

NA when local weather not available.

¹Categories A, B, 1000-2.²Category B, 900-2.

NAME ALTERNATE MINIMUMS

MC GRATH, AKMC GRATH (MCG) (PAMC).....**LOC/DME Rwy 16**
RNAV (GPS) Rwy 16
VOR/DME-C

Category C, 1200-3; Category D, 1300-3.

MEKORYUK, AKMEKORYUK (MYU) (PAMY)....**RNAV (GPS) Rwy 6**
RNAV (GPS) Rwy 24NA when local weather not available.
Category D, 900-2½.**MINCHUMINA, AK**MINCHUMINA (MHM) (PAMH).....**NDB Rwy 3¹**
RNAV (GPS) Rwy 3²
RNAV (GPS) Rwy 21²¹Categories A, B, 1000-2; Category C, 1000-2¾;
Category D, 1000-3.²Category C, 800-2¼; Category D, 800-2½.**NENANA, AK**NENANA MUNI (ENN) (PANN).....**NDB Rwy 4L**
RNAV (GPS) Rwy 4LNA when local weather not available.
Category C, 900-2¾; Category D, 900-2¾.**NEW STUYAHOK, AK**NEW STUYAHOK
(KNW) (PANW).....**RNAV (GPS) Rwy 14**
RNAV (GPS) Rwy 32

NA when local weather not available.

NOATAK, AKNOATAK (WTK) (PAWN).....**RNAV (GPS) Rwy 1**
RNAV (GPS) Rwy 19NA when local weather not available.
Category D, 800-2¼.**NOME, AK**NOME (OME) (PAOM).....**ILS Z or LOC Z Rwy 28¹**
VOR Rwy 28²¹ILS, Category D, 700-2.²Categories A, B, 1000-2; Category C, 1000-2¾;
Category D, 1000-3.**NOORVIK, AK**ROBERT/BOB/CURTIS
MEML (D76) (PFNO).....**RNAV (GPS) Rwy 6**
RNAV (GPS) Rwy 24NA when local weather not available.
Category D, 800-2¼.**NORTHWAY, AK**NORTHWAY (ORT) (PAOR)....**RNAV (GPS) Rwy 5**
RNAV (GPS) Rwy 23
VOR/DME-ANA when local weather not available.
Category D, 800-2¼.

NAME ALTERNATE MINIMUMS

NUIQSUT, AKNUIQSUT (AQT) (PAQT).....**RNAV (GPS) Rwy 5**
RNAV (GPS) Rwy 23

NA when local weather not available.

PALMER, AKWARREN "BUD" WOODS PALMER
MUNI (PAQ) (PAAQ).....**RNAV (GPS) Rwy 10**
RNAV (GPS)-A

Categories C, D, 1100-3.

PETERSBURG, AKPETERSBURG JAMES
A JOHNSON (PSG) (PAPG).....**LDA/DME-D¹**
RNAV (GPS)-B²

NA when local weather not available.

¹Category A, 1700-5; Category B, 1800-5;

Category C, 3000-5.

²Categories A, B, 2400-2; Category C, 3000-3.**PILOT POINT, AK**PILOT POINT (PNP) (PAPN)....**RNAV (GPS) Rwy 7**
RNAV (GPS) Rwy 25

NA when local weather not available.

PLATINUM, AKPLATINUM (PTU) (PAPM)....**RNAV (GPS) Rwy 14**
NA when local weather not available.**PORT ALSWORTH, AK**WILDER
RUNWAY (05K) (PAKX).....**RNAV (GPS) Rwy 6R**
NA when local weather not available.
Category A, 1000-2; Category B, 1700-2.**PORT HEIDEN, AK**PORT
HEIDEN (PTH) (PAPH).....**RNAV (GPS) Rwy 6**
RNAV (GPS) Rwy 14

NA when local weather not available.

QUINHAGAK, AKQUINHAGAK
(AQH) (PAQH).....**RNAV (GPS) Rwy 12**
RNAV (GPS) Rwy 30

NA when local weather not available.

RUBY, AKRUBY (RBY) (PARY).....**RNAV (GPS) Rwy 3**
RNAV (GPS) Rwy 21NA when local weather not available.
Category C, 800-2¼.**RUSSIAN MISSION, AK**RUSSIAN
MISSION (RSH) (PARS).....**RNAV (GPS) Rwy 18**
RNAV (GPS) Rwy 36

Category C, 1100-3; Category D, 1400-3.

NAME ALTERNATE MINIMUMS

SAND POINT, AK

SAND POINT (SDP) (PASD).....NDB Rwy 14¹
NDB Rwy 32²
RNAV (GPS) Y Rwy 14³
RNAV (GPS) Z Rwy 14³
RNAV (GPS) Rwy 32⁴

¹Categories A, B, 1900-2; Category C, 1900-3; Category D, 2200-3.

²Categories A, B, 900-2; Category C, 1500-3; Category D, 2200-3.

³Categories A, B, 900-2; Category C, 1600-3; Category D, 2300-3.

⁴Category C, 1500-3; Category D, 2200-3.

SAVOONGA, AK

SAVOONGA (SVA) (PASA).....RNAV (GPS) Rwy 5
RNAV (GPS) Rwy 23
VOR Rwy 23
VOR/DME Rwy 23

NA when local weather not available.
Category D, 1200-3.

SCAMMON BAY, AK

SCAMMON
BAY (SCM) (PACM).....RNAV (GPS) Rwy 10¹
RNAV (GPS) Rwy 28¹
RNAV (GPS)-B²

NA when local weather not available.

¹Categories A, B, 1100-2.

²Categories A, B, 800-2 $\frac{1}{4}$.

SEWARD, AK

SEWARD (SWD) (PAWD).....RNAV (GPS)-A
Categories A, B, 2700-2.

SHAGELUK, AK

SHAGELUK (SHX) (PAHX).....RNAV (GPS) Rwy 16
RNAV (GPS) Rwy 34

NA when local weather not available.
Category D, 800-2 $\frac{1}{4}$.

SHAKTOOLIK, AK

SHAKTOOLIK
(2C7) (PFSH).....RNAV (GPS) Rwy 15
RNAV (GPS) Rwy 33

NA when local weather not available.
Category D, 800-2 $\frac{1}{4}$.

SHISHMAREF, AK

SHISHMAREF
(SHH) (PASH).....RNAV (GPS) Rwy 5
RNAV (GPS) Rwy 23

NA when local weather not available.

SHUNGNAK, AK

SHUNGNAK (SHG) (PAGH).....RNAV (GPS) Rwy 10
RNAV (GPS) Rwy 28

NA when local weather not available.

NAME ALTERNATE MINIMUMS

SITKA, AK

SITKA ROCKY
GUTIERREZ (SIT) (PASI).....LDA Rwy 11¹
RNAV (GPS)-B²
RNAV (GPS) Rwy 11^{3,4}

¹Category D, 1500-3.

²Category C, 1200-3; Category D, 1600-3.

³Category A, 1300-1 $\frac{1}{4}$; Category B, 1300-1 $\frac{1}{2}$; Category C, 1300-3; Category D, 1700-3.

⁴NA when local weather not available.

SLEETMUTE, AK

SLEETMUTE (SLQ) (PASL).....RNAV (GPS) Rwy 33
NA when local weather not available.

SOLDOTNA, AK

SOLDOTNA (SXQ) (PASX).....NDB Rwy 7¹
NDB Rwy 25¹
RNAV (GPS) Rwy 7²
RNAV (GPS) Rwy 25²
VOR-A³

NA when local weather not available.

¹Category C, 800-2 $\frac{1}{2}$; Category D, 900-2 $\frac{1}{4}$.

²Category D, 900-2 $\frac{1}{4}$.

³Categories A, B, 1000-2; Category C, 1000-2 $\frac{3}{4}$; Category D, 1000-3.

SOUTH NAKNEK, AK

SOUTH NAKNEK
NR 2 (WSN) (PFWS).....RNAV (GPS) Rwy 13
RNAV (GPS) Rwy 31

NA when local weather not available

ST. GEORGE, AK

ST. GEORGE (PBV) (PAPB)....ILS or LOC Rwy 11¹
RNAV (GPS) Rwy 11²
RNAV (GPS)-D²

¹ILS, Category A, 800-2; Category B, 900-2;

Category C, 900-2 $\frac{1}{2}$; LOC, Category B, 900-2;

Category C 900-2 $\frac{1}{2}$.

²Category B, 900-2; Category C, 900-2 $\frac{1}{2}$.

ST. MARY'S, AK

ST. MARY'S (KSM) (PASM).....LOC Rwy 17
RNAV (GPS) Rwy 17
RNAV (GPS) Rwy 35

NA when local weather not available.

ST. MICHAEL, AK

ST. MICHAEL (SMK) (PAMK).....RNAV (GPS) Rwy 2
RNAV (GPS) Rwy 20

NA when local weather not available.

25 JAN 2024 to 21 MAR 2024

25 JAN 2024 to 21 MAR 2024

NAME ALTERNATE MINIMUMS

ST. PAUL ISLAND, AK

ST. PAUL ISLAND (SNP) (PASN).....**ILS or LOC Rwy 36¹**
LOC/DME BC Rwy 18²
RNAV (GPS) Rwy 18²
RNAV (GPS) Rwy 36³

¹LOC, Category D, 800-2¼.
²Category D, 800-2¼.
³Category C, 800-2¼; Category D, 800-2½.

TALKEETNA, AK

TALKEETNA (TKA) (PATK).....**RNAV (GPS) Rwy 1¹²**
RNAV (GPS) Rwy 19¹²
VOR Rwy 1²
VOR-A¹

¹Category D, 900-2¾.
²NA when local weather not available.

TANANA, AK

RALPH M CALHOUN MEML (TAL) (PATA).....**RNAV (GPS) Rwy 7**
VOR/DME Rwy 7

Categories C, D, 1100-3.

TELLER, AK

TELLER (TER) (PATA).....**RNAV (GPS) Rwy 8¹**
RNAV (GPS) Rwy 26²

NA when local weather not available.
¹Category C, 800-2¼.
²Category C, 800-2¼.

TOGIAK VILLAGE, AK

TOGIAK (TOG) (PATG).....**RNAV (GPS) Rwy 3**
RNAV (GPS) Rwy 21

Category D, 800-2½.

TOK, AK

TOK JUNCTION (6K8) (PFTO).....**RNAV (GPS) Rwy 8**
RNAV (GPS)-A

NA when local weather not available.

TOKSOOK BAY, AK

TOKSOOK BAY (OOK) (PAOO).....**RNAV (GPS) Rwy 34**
NA when local weather not available.

UNALAKLEET, AK

UNALAKLEET (UNK) (PAUN).....**LOC Rwy 15**
RNAV (GPS) Rwy 33
RNAV (GPS)-A

Category D, 900-2¾.

NAME ALTERNATE MINIMUMS

UNALASKA, AK

UNALASKA (DUT) (PADU).....**NDB-A¹**
RNAV (GPS)-B²

NA when local weather not available.
¹Categories A, B, 2900-2; Categories C, D, 2900-3.
²Categories A, B, 2000-3; Category C, 2300-3, Category D, 2500-3.

UTQIAGVIK, AK

WILEY POST-WILL ROGERS MEML (BRW) (PABR).....**ILS or LOC Rwy 8**
LOC BC Rwy 26
RNAV (GPS) Rwy 8
RNAV (GPS) Rwy 26
VOR Rwy 26

NA when local weather not available.

VALDEZ, AK

VALDEZ PIONEER FLD (VDZ) (PAVD).....**LDA-H**
NA when local weather not available.
Categories A, B, C, 4400-5; Category D, 5100-5.

WAINWRIGHT, AK

WAINWRIGHT (AWI) (PAWI).....**RNAV (GPS) Rwy 6**
RNAV (GPS) Rwy 24

NA when local weather not available.

WALES, AK

WALES (IWK) (PAIW).....**RNAV (GPS) Rwy 36**
Categories A, B, 900-2; Category C, 900-2¾;
Category D, 900-3.

WASILLA, AK

WASILLA (IYS) (PAWS).....**RNAV (GPS) Rwy 4**
RNAV (GPS) Rwy 22

NA when local weather not available.

WHITE MOUNTAIN, AK

WHITE MOUNTAIN (WMO) (PAWM).....**RNAV (GPS) Rwy 15**
RNAV (GPS) Rwy 33

NA when local weather not available.
Category C, 900-2½.

WRANGELL, AK

WRANGELL (WRG) (PAWG).....**LDA-C¹**
LDA-D²
RNAV (GPS) Rwy 10³

¹Categories A, B, 1600-3; Category C, 2500-3.
²Category D, 3300-3.
³Categories A, B, 2100-2½, Category C, 2500-3.

25 JAN 2024 to 21 MAR 2024

25 JAN 2024 to 21 MAR 2024

23334

NAME ALTERNATE MINIMUMS

NAME ALTERNATE MINIMUMS

YAKUTAT, AK

YAKUTAT

(YAK) (PAYA).....ILS or LOC Rwy 11¹
 LOC BC Rwy 29²
 RNAV (GPS) Rwy 2²
 RNAV (GPS) Rwy 11²
 RNAV (GPS) Rwy 29²
 VOR/DME Rwy 29³

¹LOC, Category C, 800-2¼; Category D, 800-2½.

²Category C, 800-2¼; Category D, 800-2½.

³Category D, 800-2¼.

25 JAN 2024 to 21 MAR 2024

25 JAN 2024 to 21 MAR 2024

23334

TAKEOFF MINIMUMS, (OBSTACLE) DEPARTURE PROCEDURES, AND DIVERSE VECTOR AREA (RADAR VECTORS)

24025

INSTRUMENT APPROACH PROCEDURE CHARTS

IFR TAKEOFF MINIMUMS AND (OBSTACLE) DEPARTURE PROCEDURES

Civil Airports and Selected Military Airports

ALL USERS: Airports that have Departure Procedures (DPs) designed specifically to assist pilots in avoiding obstacles during the climb to the minimum enroute altitude, and/or airports that have civil IFR takeoff minimums other than standard, are listed below. Takeoff Minimums and Departure Procedures apply to all runways unless otherwise specified. An entry may also be listed that contains only Takeoff Obstacle Notes. Altitudes, unless otherwise indicated, are minimum altitudes in MSL.

DPs specifically designed for obstacle avoidance are referred to as Obstacle Departure Procedures (ODPs) and are textually described below, or published separately as a graphic procedure. If the ODP is published as a graphic procedure, its name will be listed below, and it can be found in either this volume (civil), or the applicable military volume, as appropriate. Users will recognize graphic obstacle DPs by the term "(OBSTACLE)" included in the procedure title, e.g., TETON TWO (OBSTACLE). If not specifically assigned an ODP, SID, or RADAR vector as part of an IFR clearance, an ODP may be required to be flown for obstacle clearance, even though not specifically stated in the IFR clearance. When doing so in this manner, ATC should be informed when the ODP being used contains a specified route to be flown, restrictions before turning, and/or altitude restrictions.

Some ODPs, which are established solely for obstacle avoidance, require a climb in visual conditions to cross the airport, a fix, or a NAVD in a specified direction, at or above a specified altitude. These procedures are called Visual Climb Over Airport (VCOA). To ensure safe and efficient operations, the pilot must verbally request approval from ATC to fly the VCOA when requesting their IFR clearance.

At some locations where an ODP has been established, a diverse vector area (DVA) may be created to allow RADAR vectors to be used in lieu of an ODP. DVA information will state that headings will be as assigned by ATC and climb gradients, when applicable, will be published immediately following the specified departure procedure.

Graphic DPs designed by ATC to standardize traffic flows, ensure aircraft separation and enhance capacity are referred to as "Standard Instrument Departures (SIDs)". SIDs also provide obstacle clearance and are published under the appropriate airport section. ATC clearance must be received prior to flying a SID.

CIVIL USERS NOTE: Title 14 Code of Federal Regulations Part 91 prescribes standard takeoff rules and establishes takeoff minimums for certain operators as follows: (1) For aircraft, other than helicopters, having two engines or less – one statute mile visibility. (2) For aircraft having more than two engines – one-half statute mile visibility. (3) For helicopters – one-half statute mile visibility. These standard minima apply in the absence of any different minima listed below.

MILITARY USERS NOTE: Civil (nonstandard) takeoff minima are published below. For military takeoff minima, refer to appropriate service directives.

ADAK ISLAND, AK

ADAK (ADK) (PADK)

TAKEOFF MINIMUMS AND (OBSTACLE) DEPARTURE PROCEDURES

AMDT 2A 10AUG23 (23222) (FAA)

TAKEOFF MINIMUMS:

Rwy 5, std w/min climb of 370'/NM to 4400, or 4400-3 for VCOA.

Rwy 23, std w/min climb of 622'/NM to 4600, or 4400-3 for VCOA.

DEPARTURE PROCEDURE:

Rwy 5, climb on bearing 054° from ADK NDB/DME to 4400, then climbing right turn direct ADK NDB/DME to 5600, continue climb in ADK NDB holding pattern (hold northeast, right turns, 234° inbound) to cross ADK NDB/DME at or above MEA/MCA for route of flight.

Rwy 23, climb on course 234° to ADK NDB/DME to 4600, then climbing left turn direct ADK NDB/DME to 5600, continue climb in ADK NDB holding pattern (hold northeast, right turns, 234° inbound) to cross ADK NDB/DME at or above MEA/MCA for route of flight.

VCOA:

All runways, obtain ATC approval for VCOA when requesting IFR clearance. Climb in visual conditions to cross ADK NDB/DME at or above 5600 before proceeding on course.

TAKEOFF OBSTACLE NOTES:

Rwy 5, rising terrain beginning 39' from DER, 470' left of centerline, up to 50' MSL.

Rising terrain beginning 68' from DER, 244' right of centerline, up to 23' MSL.

Rwy 23, rising terrain beginning 17' from DER, 356' right of centerline, up to 283' MSL.

Bush 1.8 NM from DER, 1470' right of centerline, up to 10' AGL/507' MSL.

Bush 2 NM from DER, 20' left of centerline, up to 10' AGL/504' MSL.

Bush 3766' from DER, 142' right of centerline, 10' AGL/310' MSL.

AKHIOK, AK

AKHIOK (AKK) (PAKH)

TAKEOFF MINIMUMS AND (OBSTACLE) DEPARTURE PROCEDURES

ORIG 10MAY07 (07130) (FAA)

TAKEOFF MINIMUMS:

Rwy 22, N/A-obstacles.

DEPARTURE PROCEDURE:

Rwy 4, use JOGMO DEPARTURE.

TAKEOFF MINIMUMS, (OBSTACLE) DEPARTURE PROCEDURES, AND DIVERSE VECTOR AREA (RADAR VECTORS)

24025

TAKEOFF MINIMUMS, (OBSTACLE) DEPARTURE PROCEDURES, AND DIVERSE VECTOR AREA (RADAR VECTORS)

24025

AKIAK, AK

AKIAK (AKI) (PFAK)

TAKEOFF MINIMUMS AND (OBSTACLE) DEPARTURE PROCEDURES

ORIG 27AUG09 (09239) (FAA)

DEPARTURE PROCEDURE:

Use AKIAK DEPARTURE.

AKUTAN, AK

AKUTAN (7AK) (PAUT)

TAKEOFF MINIMUMS AND (OBSTACLE) DEPARTURE PROCEDURES

AMDT 1 05DEC19 (22195) (FAA)

DEPARTURE PROCEDURE:

Use ZEBUV DEPARTURE.

TAKEOFF OBSTACLE NOTES:

Rwy 9, terrain beginning 90' from DER, 398' right of centerline, up to 160' MSL.

Terrain beginning 198' from DER, 396' right of centerline, up to 162' MSL.

Terrain beginning 500' from DER, 398' right of centerline, up to 163' MSL.

Terrain 2038' from DER, 998' left of centerline, 202' MSL.

Terrain 2298' from DER, 998' left of centerline, 226' MSL.

Terrain beginning 2353' from DER, 923' left of centerline, up to 234' MSL.

Terrain beginning 2702' from DER, 1197' left of centerline, up to 249' MSL.

Terrain beginning 3846' from DER, 1198' left of centerline, up to 258' MSL.

Terrain beginning 3943' from DER, 1167' left of centerline, up to 263' MSL.

Rwy 27, terrain 8' from DER, 494' left of centerline, 115' MSL.

Terrain 1796' from DER, 758' left of centerline, 164' MSL.

Terrain beginning 1968' from DER, 800' left of centerline, up to 170' MSL.

Terrain beginning 2000' from DER, 740' left of centerline, up to 181' MSL.

ALLAKAKET, AK

ALLAKAKET (6A8) (PFAL)

TAKEOFF MINIMUMS AND (OBSTACLE) DEPARTURE PROCEDURES

AMDT 2 22AUG13 (13234) (FAA)

DEPARTURE PROCEDURE:

Rwy 5, climb heading 052° to 1500 before turning left.**Rwy 23**, climb heading 232° to 1300 before turning.

TAKEOFF OBSTACLE NOTES:

Rwy 5, tree 799' from DER, 606' right of centerline, 83' AGL/532' MSL.

Tree 1297' from DER, 664' right of centerline, 85' AGL/534' MSL.

Tree 2007' from DER, 342' right of centerline, 49' AGL/498' MSL.

ALLEN AAF (BIG) (PABI)

DELTA JUNCTION/FORT GREELY, AK

TAKEOFF MINIMUMS AND (OBSTACLE) DEPARTURE PROCEDURES

AMDT 5 10AUG23 (23222) (USA)

DEPARTURE PROCEDURE:

Rwys 19, 28, climbing right turn via heading 332° and BIG VORTAC R-287 to 3500, thence...**Rwys 1, 10**, climbing left turn via heading 242° and big VORTAC R-287 to 3500, thence......for V444 westbound departures continue on course, all others turn right direct BIG VORTAC or DJN NDB and proceed via
airway radials/bearings on course.

TAKEOFF OBSTACLE NOTES:

Rwy 19, power lines between 376° to 1341° from DER, beginning 179' right of centerline, and 591' left of centerline, up to
45' AGL/1327' MSL.

Tower 167' from DER, 389' left of centerline, 30' AGL/1310' MSL.

AMBLER, AK

AMBLER (AFM) (PAFM)

TAKEOFF MINIMUMS AND (OBSTACLE) DEPARTURE PROCEDURES

AMDT 1 05JAN17 (17005) (FAA)

TAKEOFF MINIMUMS:

Rwy 1, Std. w/min. climb of 260' per NM to 2400 or 3400-3 for VCOA.**Rwys 10, 28**, NA - obstacles.

DEPARTURE PROCEDURE:

Rwy 1, climbing right turn, thence...**Rwy 19**, climbing left turn, thence...

...climb southeast bound on 156° bearing from AMF NDB to 2600, then climb on course.

VCOA:

Rwy 1, obtain ATC approval for VCOA when requesting IFR clearance. Climb in visual conditions to cross Ambler airport at or
above 3500 before proceeding on course.

TAKEOFF OBSTACLE NOTES:

Rwy 1, tree 1772' from DER, 936' left of centerline, 51' AGL/315' MSL.

TAKEOFF MINIMUMS, (OBSTACLE) DEPARTURE PROCEDURES, AND DIVERSE VECTOR AREA (RADAR VECTORS)

24025

TAKEOFF MINIMUMS, (OBSTACLE) DEPARTURE PROCEDURES, AND DIVERSE VECTOR AREA (RADAR VECTORS)

24025

ANAKTUVUK PASS, AK

ANAKTUVUK PASS (AKP) (PAKP)

TAKEOFF MINIMUMS AND (OBSTACLE) DEPARTURE PROCEDURES

AMDT 2 21MAY20 (20142) (FAA)

TAKEOFF MINIMUMS:

Rwy 20, NA-obstacles.

DEPARTURE PROCEDURE:

Rwy 2, Use AKUMY RNAV DEPARTURE.

ANCHORAGE, AK

MERRILL FLD (MRI) (PAMR)

TAKEOFF MINIMUMS AND (OBSTACLE) DEPARTURE PROCEDURES

AMDT 2 05DEC19 (21112) (FAA)

TAKEOFF MINIMUMS:

Rwys 5, 23, NA - ATC.**Rwy 7**, 300-1½ or std. w/min. climb of 210' per NM to 400, or alternatively, with std. takeoff minimums and normal 200' per NM climb gradient, takeoff must occur no later than 1300' prior to DER.**Rwy 25**, 300-1½ or std. w/min. climb of 365' per NM to 500.

DEPARTURE PROCEDURE:

Rwy 7, climbing left turn to intercept the BGQ VORTAC R-152 to BGQ VORTAC, thence...**Rwy 16**, climbing right turn to intercept the BGQ VORTAC R-152 to BGQ VORTAC, thence...**Rwy 25**, climbing right turn direct BGQ VORTAC, thence...**Rwy 34**, climbing left turn direct BGQ VORTAC, thence...

...climb in BGQ VORTAC holding pattern (hold north, right turn 175° inbound) to MEA/MCA for route of flight before proceeding on course.

TAKEOFF OBSTACLE NOTES:

Rwy 7, building 165' from DER, 363' right of centerline, 34' AGL/168' MSL.

Tree 749' from DER, 208' left of centerline, 163' MSL.

Tower 1.5 NM from DER, 2017' right of centerline, 160' AGL/384' MSL.

Rwy 16, NAVAID 14' from DER, 199' left of centerline, 32' AGL/131' MSL.

Trees beginning 96' from DER, 199' right of centerline, up to 186' MSL.

Tree 679' from DER, 364' right of centerline, 193' MSL.

Rwy 25, pole 19' from DER, 370' right of centerline, 37' AGL/157' MSL.

Pole, building beginning 343' from DER, 358' right of centerline, up to 50' AGL/165' MSL.

Pole 1185' from DER, 385' right of centerline, 65' AGL/180' MSL.

Tower 1745' from DER, 272' left of centerline, 75' AGL/195' MSL.

Tower, transmission line, pole beginning 1770' from DER, 310' left of centerline, up to 83' AGL/202' MSL.

Transmission line, pole beginning 2011' from DER, 410' right of centerline, up to 84' AGL/196' MSL.

Tower 2453' from DER, 990' right of centerline, 87' AGL/211' MSL.

Tower 2894' from DER, 431' left of centerline, 86' AGL/224' MSL.

Bldg twr 4020' from DER, 381' right of centerline, 193' AGL/293' MSL.

Buildings beginning 4025' from DER, 440' right of centerline, up to 189' AGL/306' MSL.

Building 1.1 NM from DER, 1257' right of centerline, 262' AGL/361' MSL.

Tower 1.1 NM from DER, 1296' right of centerline, 285' AGL/383' MSL.

Bldg twr, building beginning 1.1 NM from DER, 212' left of centerline, up to 312' AGL/422' MSL.

Rwy 34, pole 451' from DER, 158' left of centerline, 37' AGL/157' MSL.

Buildings, pole beginning 503' from DER, 261' right of centerline, up to 173' MSL.

Pole 539' from DER, 483' left of centerline, 50' AGL/165' MSL.

Building 1071' from DER, 345' right of centerline, 78' AGL/178' MSL.

TED STEVENS ANCHORAGE INTL (ANC) (PANC)

TAKEOFF MINIMUMS AND (OBSTACLE) DEPARTURE PROCEDURES

AMDT 8 10OCT19 (19283) (FAA)

TAKEOFF MINIMUMS:

Rwy 7L, 300-1½ or std. w/min. climb of 255' per NM to 1600.**Rwy 7R**, 300-1 or std. w/min. climb of 285' per NM to 400.**Rwy 15**, 300-1½ or std. w/min. climb of 205' per NM to 400.

DEPARTURE PROCEDURE:

Rwys 7L, 7R, 15, climbing right turn heading 252°, thence...**Rwys 25L, 25R**, climbing left turn heading 182°, thence...**Rwy 33**, climbing left turn heading 162°, thence...

...on TED VOR/DME R-210 and ENA VOR/DME R-028 to ENA VOR/DME before proceeding on course.

TAKEOFF OBSTACLE NOTES:

Rwy 7L, vegetation 10' from DER, 492' right of centerline, 95' MSL.

NAVAID 10' from DER, 55' left of centerline, 10' AGL/92' MSL. Tree 789' from DER, 590' left of centerline, 133' MSL.

Trees beginning 934' from DER, 535' left of centerline, up to 142' MSL.

Tree, pole beginning 1037' from DER, 546' left of centerline, up to 148' MSL.

Tree 1172' from DER, 738' right of centerline, 148' MSL.

Tree, pole, transmission line beginning 1366' from DER, 8' right of centerline, up to 158' MSL.

Trees beginning 1625' from DER, 100' left of centerline, up to 152' MSL.

Trees beginning 1983' from DER, 32' left of centerline, up to 174' MSL.

Pole 3636' from DER, 1249' right of centerline, 92' AGL/184' MSL.

CONT

25 JAN 2024 to 21 MAR 2024

25 JAN 2024 to 21 MAR 2024

TAKEOFF MINIMUMS, (OBSTACLE) DEPARTURE PROCEDURES, AND DIVERSE VECTOR AREA (RADAR VECTORS)

24025

AK

TAKEOFF MINIMUMS, (OBSTACLE) DEPARTURE PROCEDURES, AND DIVERSE VECTOR AREA (RADAR VECTORS)

24025

ANCHORAGE, AK (CON'T)

TED STEVENS ANCHORAGE INTL (ANC) (PANC) (CON'T)

Rwy 7L (CON'T), pole 5244' from DER, 1181' left of centerline, 174' AGL/257' MSL.

Pole 5756' from DER, 761' left of centerline, 171' AGL/259' MSL.

Rwy 7R, terrain beginning 10' from DER, 167' right of centerline, up to 103' MSL.

Sign 106' from DER, 462' right of centerline, 9' AGL/111' MSL.

Pole, terrain, vegetation beginning 204' from DER, 537' right of centerline, up to 12' AGL/117' MSL.

Pole beginning 816' from DER, 698' right of centerline, up to 30' AGL/132' MSL.

Trees beginning 1039' from DER, 599' right of centerline, up to 159' MSL.

Trees beginning 1242' from DER, 573' right of centerline, up to 172' MSL.

Trees beginning 3121' from DER, 1220' right of centerline, up to 183' MSL.

Tree 3334' from DER, 1277' right of centerline, 189' MSL.

Tree 3497' from DER, 1203' right of centerline, 192' MSL.

Trees beginning 3921' from DER, 1003' right of centerline, up to 221' MSL.

Trees beginning 4209' from DER, 1415' right of centerline, up to 224' MSL.

Trees beginning 4274' from DER, 1209' right of centerline, up to 236' MSL.

Tree 4325' from DER, 1401' right of centerline, 237' MSL.

Tree 4363' from DER, 1479' right of centerline, 246' MSL.

Tree, tower, tank beginning 4378' from DER, 1139' right of centerline, up to 255' MSL.

Rwy 15, terrain, sign beginning 42' from DER, 422' right of centerline, up to 125' MSL.

Sign 59' from DER, 367' right of centerline, 10' AGL/126' MSL.

Trees beginning 1776' from DER, 384' right of centerline, up to 183' MSL.

Trees beginning 1879' from DER, 188' right of centerline, up to 187' MSL.

Tree 2010' from DER, 814' right of centerline, 189' MSL.

Tree 2011' from DER, 215' left of centerline, 172' MSL.

Trees beginning 2014' from DER, 32' left of centerline, up to 179' MSL.

Trees beginning 2019' from DER, 3' right of centerline, up to 200' MSL.

Tree 2073' from DER, 806' right of centerline, 201' MSL.

Trees beginning 2075' from DER, 5' right of centerline, up to 205' MSL.

Trees beginning 2337' from DER, 102' right of centerline, up to 206' MSL.

Tree 2472' from DER, 941' left of centerline, 187' MSL.

Tree 2506' from DER, 1002' left of centerline, 193' MSL.

Trees beginning 2524' from DER, 774' left of centerline, up to 195' MSL.

Tree 2659' from DER, 784' left of centerline, 196' MSL.

Trees beginning 2667' from DER, 242' left of centerline, up to 198' MSL.

Tree 2819' from DER, 257' left of centerline, 212' MSL.

Water tower 2829' from DER, 1069' left of centerline, 97' AGL/222' MSL.

Tower, tree beginning 2830' from DER, 177' left of centerline, up to 106' AGL/227' MSL.

Antenna, tower, tree beginning 2853' from DER, 83' left of centerline, up to 108' AGL/233' MSL.

Trees beginning 3021' from DER, 487' right of centerline, up to 209' MSL.

Tree 3112' from DER, 486' right of centerline, 213' MSL.

Tree 3133' from DER, 590' right of centerline, 214' MSL.

Trees beginning 3163' from DER, 458' right of centerline, up to 217' MSL.

Trees beginning 4055' from DER, 607' left of centerline, up to 247' MSL.

Tree 4482' from DER, 1517' right of centerline, 238' MSL.

Tree 5180' from DER, 398' right of centerline, 254' MSL.

Tree 5411' from DER, 658' right of centerline, 261' MSL.

Trees beginning 5503' from DER, 591' right of centerline, up to 270' MSL.

Trees beginning 5531' from DER, 590' right of centerline, up to 273' MSL.

Tree 1.2 NM from DER, 2433' right of centerline, 310' MSL.

Rwy 25L, NAVIAID 4' from DER, on centerline, 11' AGL/135' MSL.

Vegetation 17' from DER, 500' left of centerline, 143' MSL.

Fence 422' from DER, 601' left of centerline, 13' AGL/166' MSL.

Fence 454' from DER, 530' left of centerline, 14' AGL/168' MSL.

Tree, vegetation beginning 843' from DER, 524' left of centerline, up to 174' MSL.

Trees beginning 1196' from DER, 601' left of centerline, up to 193' MSL.

Trees beginning 1301' from DER, 576' left of centerline, up to 194' MSL.

Trees beginning 1438' from DER, 771' left of centerline, up to 196' MSL.

Rwy 25R, NAVIAID 9' from DER, 55' right of centerline, 6' AGL/128' MSL.

Rwy 33, vegetation 88' from DER, 496' right of centerline, 155' MSL.

Tree 991' from DER, 580' right of centerline, 177' MSL.

Tree 1035' from DER, 765' right of centerline, 229' MSL.

DIVERSE VECTOR AREA (RADAR VECTORS)

AMDT 2 29MAR18 (18088) (FAA)

Rwy 7L, heading as assigned by ATC; requires min. climb of 260' per NM to 600.

Rwys 25L, 25R, 33, heading as assigned by ATC.

25 JAN 2024 to 21 MAR 2024

25 JAN 2024 to 21 MAR 2024

TAKEOFF MINIMUMS, (OBSTACLE) DEPARTURE PROCEDURES, AND DIVERSE VECTOR AREA (RADAR VECTORS)

24025

TAKEOFF MINIMUMS, (OBSTACLE) DEPARTURE PROCEDURES, AND DIVERSE VECTOR AREA (RADAR VECTORS)

24025

ANIAK, AK

ANIAK (ANI) (PANI)

TAKEOFF MINIMUMS AND (OBSTACLE) DEPARTURE PROCEDURES

AMDT 4 10SEP20 (20254) (FAA)

TAKEOFF MINIMUMS:

Rwy 11, std. w/min. climb of 275' per NM to 3900, or 2800-3 for VCOA.

Rwy 29, std. w/min. climb of 315' per NM to 1000, or 2800-3 for VCOA.

DEPARTURE PROCEDURE:

Rwy 11, climb heading 109° to 2800 before turning left.

Rwy 29, climb heading 289° to 1800 before proceeding on course.

VCOA:

All runways, obtain ATC approval for VCOA when requesting IFR clearance. Climb in visual conditions to cross Aniak Airport at or above 2700 before proceeding on course.

TAKEOFF OBSTACLE NOTES:

Rwy 11, fence 5' from DER, 203' right of centerline, 8' AGL/99' MSL.

Traverse way 19' from DER, 241' right of centerline, 108' MSL.

Tree 21' from DER, 498' right of centerline, 47' AGL/137' MSL.

Traverse way 73' from DER, 184' right of centerline, 107' MSL.

Traverse way 133' from DER, 136' right of centerline, 107' MSL.

Building 146' from DER, 490' right of centerline, 12' AGL/103' MSL.

Poles, traverse ways, trees, buildings beginning 177' from DER, 46' right of centerline, up to 18' AGL/108' MSL.

Antennas, trees, buildings, poles, vertical structure beginning 500' from DER, 116' right of centerline, up to 54' AGL/148' MSL.

Tree 587' from DER, 636' left of centerline, 50' AGL/141' MSL.

Tree 625' from DER, 642' left of centerline, 53' AGL/145' MSL.

Trees, pole beginning 710' from DER, 639' left of centerline, up to 62' AGL/154' MSL.

Trees beginning 1858' from DER, 135' right of centerline, up to 64' AGL/160' MSL.

Trees beginning 2099' from DER, 558' right of centerline, up to 74' AGL/165' MSL.

Rwy 29, pole, tree beginning 309' from DER, 363' left of centerline, up to 29' AGL/119' MSL.

Trees beginning 453' from DER, 346' left of centerline, up to 32' AGL/126' MSL.

Tree 518' from DER, 536' left of centerline, 35' AGL/127' MSL.

Trees beginning 522' from DER, 433' left of centerline, up to 42' AGL/133' MSL.

Trees beginning 589' from DER, 296' left of centerline, up to 42' AGL/134' MSL.

Trees beginning 778' from DER, 309' left of centerline, up to 55' AGL/146' MSL.

Trees beginning 1.9 NM from DER, 1658' right of centerline, up to 46' AGL/395' MSL.

Trees beginning 1.9 NM from DER, 1225' right of centerline, up to 52' AGL/442' MSL.

Trees beginning 1.9 NM from DER, 1256' right of centerline, up to 37' AGL/452' MSL.

Tree 2 NM from DER, 2230' right of centerline, 19' AGL/458' MSL.

Trees beginning 2 NM from DER, 1705' right of centerline, up to 31' AGL/461' MSL.

Trees beginning 2 NM from DER, 2181' right of centerline, up to 29' AGL/467' MSL.

Trees beginning 2.2 NM from DER, 2959' right of centerline, up to 28' AGL/491' MSL.

Tree 2.2 NM from DER, 2662' right of centerline, 33' AGL/494' MSL.

Trees beginning 2.2 NM from DER, 2647' right of centerline, up to 38' AGL/498' MSL.

Tree 2.3 NM from DER, 3131' right of centerline, 24' AGL/510' MSL.

Trees beginning 2.3 NM from DER, 2736' right of centerline, up to 32' AGL/520' MSL.

Tree 2.3 NM from DER, 3245' right of centerline, 36' AGL/545' MSL.

Trees beginning 2.3 NM from DER, 3227' right of centerline, up to 659' MSL.

ANVIK, AK

ANVIK (ANV) (PANV)

TAKEOFF MINIMUMS AND (OBSTACLE) DEPARTURE PROCEDURES

ORIG 25SEP08 (08269) (FAA)

TAKEOFF OBSTACLE NOTES:

Rwy 17, multiple trees beginning 56' from DER, 30' left of centerline, up to 50' AGL/436' MSL.

Multiple trees beginning 87' from DER, 38' right of centerline, up to 50' AGL/349' MSL.

Rwy 35, Multiple trees beginning 93' from DER, 129' left of centerline, up to 50' AGL/349' MSL.

Multiple trees beginning 8' from DER, 10' right of centerline, up to 50' AGL/366' MSL.

ARCTIC VILLAGE, AK

ARCTIC VILLAGE (ARC) (PARC)

TAKEOFF MINIMUMS AND (OBSTACLE) DEPARTURE PROCEDURES

ORIG 16FEB06 (06047) (FAA)

DEPARTURE PROCEDURE:

Use TUVVO DEPARTURE.

ATKA, AK

ATKA (AKA) (PAAK)

TAKEOFF MINIMUMS AND (OBSTACLE) DEPARTURE PROCEDURES

AMDT 1 29JUL10 (10210) (FAA)

DEPARTURE PROCEDURE:

Rwy 16, use HIMKI DEPARTURE.

Rwy 34, use INOTY DEPARTURE.

TAKEOFF MINIMUMS, (OBSTACLE) DEPARTURE PROCEDURES, AND DIVERSE VECTOR AREA (RADAR VECTORS)

24025

AK

TAKEOFF MINIMUMS, (OBSTACLE) DEPARTURE PROCEDURES, AND DIVERSE VECTOR AREA (RADAR VECTORS)

24025

ATQASUK, AK

ATQASUK EDWARD BURNELL SR MEML (ATK) (PATQ)
TAKEOFF MINIMUMS AND (OBSTACLE) DEPARTURE PROCEDURES
ORIG-A 31DEC20 (21112) (FAA)

TAKEOFF OBSTACLE NOTES:

- Rwy 7**, lighting beginning at DER, 55' left of centerline, up to 101' MSL.
Lighting beginning at DER, 34' right of centerline, up to 101' MSL.
- Rwy 25**, lighting beginning at DER, 76' right of centerline, up to 103' MSL.

BEAVER, AK

BEAVER (WBQ) (PAWB)
TAKEOFF MINIMUMS AND (OBSTACLE) DEPARTURE PROCEDURES
ORIG 27AUG09 (09239) (FAA)

TAKEOFF OBSTACLE NOTES:

- Rwy 5**, multiple trees beginning 229' from DER, 262' right of centerline, up to 60' AGL/419' MSL.
Multiple trees beginning 1263' from DER, 373' right of centerline, up to 60' AGL/419' MSL.
Vehicle on road 392' from DER, 9' right of centerline, 10' AGL/369' MSL.
- Rwy 23**, multiple trees beginning 1259' from DER, 374' right of centerline, up to 60' AGL/419' MSL.
Multiple trees beginning 1277' from DER, 366' left of centerline, up to 60' AGL/419' MSL.

BETHEL, AK

BETHEL (BET) (PABE)
TAKEOFF MINIMUMS AND (OBSTACLE) DEPARTURE PROCEDURES
AMDT 4 22JUN17 (17173) (FAA)

TAKEOFF MINIMUMS:

- Rwy 30**, 300-1% or std. w/ min. climb of 240' per NM to 400.

TAKEOFF OBSTACLE NOTES:

- Rwy 1L**, bush and wind sock, beginning 7' from DER, 92' right of centerline. up to 10' AGL/108' MSL.
Wind sock 99' from DER, 282' left of centerline. 9' AGL/105' MSL.
- Rwy 1R**, tree 124' from DER, 452' left of centerline, 125' MSL.
- Rwy 12L**, bushes beginning 13' from DER, 58' left of centerline. 2' AGL/128' MSL.
- Rwy 19L**, bush 40' from DER, 427' right of centerline, 4' AGL/125' MSL.
Trees beginning 20' from DER, 175' right of centerline, up to 130' MSL.
- Rwy 19R**, tree 11' from DER, 477' right of centerline. 11' AGL/131' MSL.
Trees beginning 21' from DER, 312' left of centerline, up to 130' MSL.
Vehicles on road beginning 46' from DER, 484' right of centerline, up to 15' AGL/132' MSL.
Wind sock and pole 214' from DER, 400' right of centerline, up to 35' AGL/133' MSL.
Wind sock 218' from DER, 414' right of centerline, 10' AGL/133' MSL.
- Rwy 30**, building, antenna on building, and a vent beginning 312' from DER 532' right of centerline, up to 25' AGL/148' MSL.
Tower 5780' from DER, 66' right of centerline, 139' AGL/294' MSL.

BETTLES, AK

BETTLES (BTT) (PABT)
TAKEOFF MINIMUMS AND (OBSTACLE) DEPARTURE PROCEDURES
AMDT 3 24MAY18 (18144) (FAA)

TAKEOFF MINIMUMS:

- Rwy 2**, 500 and 2½ or std. w/ min. climb of 285' per NM to 1200.

DEPARTURE PROCEDURE:

- Rwy 2**, climb heading 016° to 2500 then climbing left turn to 3600 direct BTT VOR/DME, continue climb in BTT holding pattern (hold south, left turn, 338° inbound) to cross BTT VOR/DME at or above MEA/MCA for route of flight.

- Rwy 20**, climb heading 196° to 2000 then climbing left turn to 3600 direct BTT VOR/DME, continue climb in BTT VOR/DME holding pattern (hold south, left turn, 338° inbound) to cross BTT VOR/DME at or above MEA/MCA for route of flight.

TAKEOFF OBSTACLE NOTES:

- Rwy 2**, vehicle on road 4' from DER, 108' left of centerline, 660' MSL.
Vehicle on road 19' from DER, 165' right of centerline, 659' MSL.
Tree, vehicle on road beginning 24' from DER, 25' left of centerline, up to 37' AGL/671' MSL.
Vehicle on road 49' from DER, 71' right of centerline, 660' MSL.
Trees beginning 138' from DER, 29' left of centerline, up to 45' AGL/679' MSL.
Tree 410' from DER, 587' right of centerline, 41' AGL/684' MSL.
Trees beginning 506' from DER, 108' right of centerline, up to 48' AGL/691' MSL.
Tree 2016' from DER, 972' left of centerline, 65' AGL/698' MSL.
Tree 2108' from DER, 870' left of centerline, 72' AGL/704' MSL.
Tree 2432' from DER, 1112' left of centerline, 78' AGL/712' MSL.
Tree 1.7 NM from DER, 2988' right of centerline, 67' AGL/929' MSL.
Trees beginning 1.8 NM from DER, 2436' right of centerline, up to 38' AGL/1037' MSL.
Tree, terrain + veg beginning 1.9 NM from DER, 1946' right of centerline, up to 44' AGL/1059' MSL.
- Rwy 20**, vehicle on road 2' from DER, 112' left of centerline, 649' MSL.
Tree, sign, vehicle on road, vegetation, antenna beginning 2' from DER, 16' left of centerline, up to 36' AGL/670' MSL.
Sign 9' from DER, 93' right of centerline, 4' AGL/638' MSL.
Trees beginning 104' from DER, 189' right of centerline, up to 30' AGL/666' MSL.
Trees beginning 139' from DER, 11' right of centerline, up to 38' AGL/674' MSL.
Trees beginning 342' from DER, 270' right of centerline, up to 52' AGL/687' MSL.

TAKEOFF MINIMUMS, (OBSTACLE) DEPARTURE PROCEDURES, AND DIVERSE VECTOR AREA (RADAR VECTORS)

24025

TAKEOFF MINIMUMS, (OBSTACLE) DEPARTURE PROCEDURES, AND DIVERSE VECTOR AREA (RADAR VECTORS)

24025

BIG LAKE, AK

BIG LAKE (BGQ) (PAGQ)

TAKEOFF MINIMUMS AND (OBSTACLE) DEPARTURE PROCEDURES

AMDT 2 09FEB12 (12040) (FAA)

TAKEOFF MINIMUMS:

Rwy 7, 300-1 w/ min. climb of 310' per NM to 700, or 900-2½ for climb in visual conditions.**Rwy 25**, 400-2 or std. w/min. climb of 320' per NM to 700.

DEPARTURE PROCEDURE:

Rwy 7, climbing left turn to BGQ VORTAC, thence..., or for climb in visual conditions cross Big Lake Airport at or above 900 then proceed direct BGQ VORTAC, thence...**Rwy 25**, climbing right turn direct BGQ VORTAC, thence...

...climb in BGQ VORTAC holding pattern (hold S, left turn, 356° inbound) to MCA/MEA for route of flight.

TAKEOFF OBSTACLE NOTES:

Rwy 7, bushes beginning 33' from DER, 335' left of centerline, up to 10' AGL/259' MSL.

Multiple trees beginning 1150' from DER, 310' left of centerline, up to 60' AGL/409' MSL.

Multiple trees beginning 2265' from DER, 708' right of centerline, up to 60' AGL/309' MSL.

Rwy 25, trees beginning 33' from DER, 109' left of centerline, up to 60' AGL/259' MSL.

Trees beginning 960' from DER, 185' right of centerline, up to 60' AGL/259' MSL.

BREVIK MISSION, AK

BREVIK MISSION (KTS) (PFKT)

TAKEOFF MINIMUMS AND (OBSTACLE) DEPARTURE PROCEDURES

AMDT 1 05OCT23 (23278) (FAA)

TAKEOFF MINIMUMS:

Rwy 5, NA-Terrain.

DEPARTURE PROCEDURE:

Rwys 12, 23, 30, use BREVIK DEPARTURE.

TAKEOFF OBSTACLE NOTES:

Rwy 12, vegetation 154' from DER, 373' right of centerline, 40' MSL.

Power line 803' from DER, 632' right of centerline, 34' AGL/62' MSL.

Rwy 23, vehicle on road 136' from DER, 440' left of centerline, 14' AGL/53' MSL.

Pole 262' from DER, 543' right of centerline, 45' AGL/60' MSL.

BRYANT AAF (FRN) (PAFR)

FORT RICHARDSON (ANCHORAGE), AK

TAKEOFF MINIMUMS AND (OBSTACLE) DEPARTURE PROCEDURES

AMDT 1 10AUG23 (23222) (USA)

TAKE-OFF MINIMUMS:

Rwy 18, NA-Airspace.

DEPARTURE PROCEDURE:

Rwy 36, OIS 40:1 evaluation at DER begins at 0', climbing left turn direct BGQ VORTAC. Maintain ATC assigned altitude.

TAKEOFF OBSTACLE NOTES:

Rwy 36, treeline 81' from DER, 171' left of centerline, 100' AGL/422' MSL.

Power lines 611' from DER, 526' left of centerline, 40' AGL/424' MSL.

DIVERSE VECTOR AREA (RADAR VECTORS)

ORIG 30APR15 (15120) (FAA)

Rwy 35, heading as assigned by ATC.

BUCKLAND, AK

BUCKLAND (BVK) (PABL)

TAKEOFF MINIMUMS AND (OBSTACLE) DEPARTURE PROCEDURES

AMDT 2A 10AUG23 (23222) (FAA)

TAKEOFF MINIMUMS:

Rwy 11, std w/min climb of 245'/NM to 900 or 1800-3 for VCOA.

DEPARTURE PROCEDURE:

Rwy 11, climb on a heading between 320° CW 220° from DER to 3000 before proceeding on course.**Rwy 29**, climb on a heading between 285° CW 105° from DER to 3000 before proceeding on course.

VCOA:

Obtain ATC approval for VCOA when requesting IFR clearance. Climb in visual conditions to cross Buckland airport at or above 1700 before proceeding on course.

TAKEOFF OBSTACLE NOTES:

Rwy 11, tree 8' from DER, 183' left of centerline, 43' MSL.

Wind indicator 63' from DER, 313' left of centerline, 24' AGL/49' MSL.

Pole 1142' from DER, 435' left of centerline, 33' AGL/62' MSL.

Pole 1434' from DER, 150' right of centerline, 48' AGL/69' MSL.

Tower 1494' from DER, 109' right of centerline, 50' AGL/74' MSL.

Antenna 1651' from DER, 269' left of centerline, 74' AGL/96' MSL.

Towers beginning 1656' from DER, 268' left of centerline, up to 71' AGL/97' MSL.

Rwy 29, lighting 10' from DER, 58' right of centerline, 2' AGL/28' MSL.

Lighting 10' from DER, 56' left of centerline, 2' AGL/28' MSL.

TAKEOFF MINIMUMS, (OBSTACLE) DEPARTURE PROCEDURES, AND DIVERSE VECTOR AREA (RADAR VECTORS)

24025

AK

TAKEOFF MINIMUMS, (OBSTACLE) DEPARTURE PROCEDURES, AND DIVERSE VECTOR AREA (RADAR VECTORS)

24025

CAPE LISBURNE LRRS (LUR) (PALU)

CAPE LISBURNE

TAKEOFF MINIMUMS AND (OBSTACLE) DEPARTURE PROCEDURES

AMDT 2 08NOV18 (18312)

Diverse departures NA.

DEPARTURE PROCEDURE:

Rwy 9, use GRAAY DEPARTURE (RNAV 1).**Rwy 27**, NA.

TAKEOFF OBSTACLE NOTES:

Rwy 9, terrain 0' from DER, 106' left of cntrln, 15' MSL.

Terrain 0' from DER, 500' right of cntrln, 41' MSL.

Terrain 1495' from DER, 867' right of cntrln, 56' MSL.

Terrain 1521' from DER, 908' right of cntrln, 58' MSL.

Terrain 28' from DER, 213' right of cntrln, 33' MSL.

Terrain 300' from DER, 472' right of cntrln, 36' MSL.

Terrain 380' from DER, 602' right of cntrln, 36' MSL.

Building 1417' from DER, 482' right of cntrln, 0' AGL/108' MSL.

Building 2428' from DER, 539' right of cntrln, 0' AGL/80' MSL.

Building 234' from DER, 517' right of cntrln, 70' AGL/107' MSL.

Building 3730' from DER, 561' right of cntrln, 0' AGL/81' MSL.

Building 729' from DER, 560' right of cntrln, 54' AGL/80' MSL.

Fuel tank 485' from DER, 579' right of cntrln, 0' AGL/64' MSL.

Radar dish 1361' from DER, 522' right of cntrln, 0' AGL/91' MSL.

Radar dish 1576' from DER, 541' right of cntrln, 0' AGL/82' MSL.

Twr 2419' from DER, 532' right of cntrln, 110' AGL/151' MSL.

Weather equipment 1278' from DER, 19' left of cntrln, 0' AGL/68' MSL.

CAPE NEWENHAM LRRS (EHM) (PAEH)

CAPE NEWENHAM, AK

TAKEOFF MINIMUMS AND (OBSTACLE) DEPARTURE PROCEDURES

ORIG 10DEC15 (15344)

Diverse departures not authorized.

DEPARTURE PROCEDURE:

Rwy 15, NA.**Rwy 33**, use CABNN ONE DEPARTURE.

TAKEOFF OBSTACLE NOTES:

Rwy 33, terrain abeam the DER, 106' left of centerline, 228' MSL.

Terrain abeam the DER, 25' right of centerline, 237' MSL.

Terrain 203' from DER, 396' right of centerline, 249' MSL.

CAPE ROMANZOF LRRS (CZF) (PACZ)

CAPE ROMANZOF, AK

TAKEOFF MINIMUMS AND (OBSTACLE) DEPARTURE PROCEDURES

AMDT 3, 31MAR16 (16091)

Diverse departures not authorized.

DEPARTURE PROCEDURE:

Rwy 2, NA.**Rwy 20**, use CAPE ROMANZOF DEPARTURE.

TAKEOFF OBSTACLE NOTES:

Rwy 20, terrain, 237' from DER, 563' left of centerline, 451' MSL.

Terrain, 261' from DER, 499' left of centerline, 433' MSL.

Terrain, at the DER, 500' left of centerline, 454' MSL.

CENTRAL, AK

CENTRAL (CEM) (PACE)

TAKEOFF MINIMUMS AND (OBSTACLE) DEPARTURE PROCEDURES

ORIG 29MAY14 (14149) (FAA)

TAKEOFF MINIMUMS:

Rwys 8, 26, 2900-3 for climb in visual conditions.

DEPARTURE PROCEDURE:

Rwys 8, 26, for climb in visual conditions, cross Central Airport at or above 3700 before proceeding on course. When executing VCOA, notify ATC prior to departure.

TAKEOFF OBSTACLE NOTES:

Rwy 8, trees beginning 149' from DER, left and right of centerline, up to 73' AGL/972' MSL.**Rwy 26**, trees beginning 80' from DER, left and right of centerline, up to 78' AGL/1045' MSL.

Building, 179' from DER, 204' left of centerline, 23' AGL/952' MSL.

Pole/antenna on buildings beginning 228' from DER, 198' left of centerline, up to 46' AGL/982' MSL.

Vehicle on road, 491' from DER, 3' right of centerline, 15' AGL/955' MSL.

Vent/chimney on buildings beginning 736' from DER, 10' right of centerline, up to 25' AGL/964' MSL.

Building, 79' from DER, 294' right of centerline, 19' AGL/951' MSL.

Vehicles on road beginning 84' from DER, 410' right of centerline, up to 15' AGL/951' MSL.

Pole, 532' from DER, 298' right of centerline, 39' AGL/978' MSL.

TAKEOFF MINIMUMS, (OBSTACLE) DEPARTURE PROCEDURES, AND DIVERSE VECTOR AREA (RADAR VECTORS)

24025

TAKEOFF MINIMUMS, (OBSTACLE) DEPARTURE PROCEDURES, AND DIVERSE VECTOR AREA (RADAR VECTORS)

24025

CHALKYITSIK, AK

CHALKYITSIK (CIK) (PACI)

TAKEOFF MINIMUMS AND (OBSTACLE) DEPARTURE PROCEDURES

AMDT 2 16JUL20 (20198) (FAA)

TAKEOFF OBSTACLE NOTES:

Rwy 4, vehicle on road 3' from DER, 432' right of centerline, 559' MSL.

Vehicle on road, tree beginning 42' from DER, 354' right of centerline, up to 560' MSL.

Vegetation 73' from DER, 86' left of centerline, 9' AGL/557' MSL.

Vehicle on road 77' from DER, 282' right of centerline, 561' MSL.

Tree, vegetation beginning 78' from DER, 158' right of centerline, up to 45' AGL/565' MSL.

Wind indicator, vehicle on roads, trees, vegetation beginning 111' from DER, 25' right of centerline, up to 21' AGL/572' MSL.

Vehicle on road 134' from DER, 228' left of centerline, 561' MSL.

Vehicle on road 158' from DER, 247' left of centerline, 562' MSL.

Trees, vegetation, vehicle on roads beginning 168' from DER, 219' left of centerline, up to 54' AGL/607' MSL.

Trees, vehicle on roads, buildings, tanks, vertical structures, poles, fences, catenaries, antennas beginning 208' from DER,

111' left of centerline, up to 56' AGL/609' MSL.

Trees, buildings, vertical structures, fences, poles, vehicle on roads, antennas, catenaries beginning 586' from DER, 311' left

of centerline, up to 54' AGL/611' MSL.

Tree 908' from DER, 700' right of centerline, 50' AGL/577' MSL.

Tree 1111' from DER, 583' right of centerline, 53' AGL/582' MSL.

Tree 1187' from DER, 762' right of centerline, 68' AGL/592' MSL.

Trees beginning 1356' from DER, 455' right of centerline, up to 82' AGL/609' MSL.

Rwy 22, tree, NAVAIDs beginning 1' from DER, 27' right of centerline, up to 15' AGL/538' MSL.

NAVAID 10' from DER, 47' left of centerline, 1' AGL/529' MSL.

NAVAID 10' from DER, 27' left of centerline, 2' AGL/530' MSL.

Trees beginning 21' from DER, 113' left of centerline, up to 20' AGL/546' MSL.

Tree 27' from DER, 338' right of centerline, 46' AGL/570' MSL.

Tree 29' from DER, 263' right of centerline, 52' AGL/575' MSL.

Trees beginning 162' from DER, 55' right of centerline, up to 59' AGL/582' MSL.

Tree 173' from DER, 369' left of centerline, 35' AGL/561' MSL.

Trees beginning 191' from DER, 23' left of centerline, up to 39' AGL/563' MSL.

Trees beginning 811' from DER, 415' left of centerline, up to 44' AGL/568' MSL.

Trees beginning 854' from DER, 394' left of centerline, up to 54' AGL/578' MSL.

Trees beginning 900' from DER, 29' left of centerline, up to 56' AGL/579' MSL.

Tree 1634' from DER, 928' left of centerline, 64' AGL/586' MSL.

Trees beginning 1910' from DER, 675' left of centerline, up to 68' AGL/590' MSL.

CHEVAK, AK

CHEVAK (VAK) (PAVA)

TAKEOFF MINIMUMS AND (OBSTACLE) DEPARTURE PROCEDURES

AMDT 2 30JAN20 (22139) (FAA)

TAKEOFF OBSTACLE NOTES:

Rwy 20, lighting 0' from DER, 66' right of centerline, 3' AGL/48' MSL

CHUATHBALUK, AK

CHUATHBALUK (9A3) (PACH)

TAKEOFF MINIMUMS AND (OBSTACLE) DEPARTURE PROCEDURES

ORIG 22OCT09 (09295) (FAA)

DEPARTURE PROCEDURE:

See EBSIH DEPARTURE.

CLARKS POINT, AK

CLARKS POINT (CLP) (PFCL)

TAKEOFF MINIMUMS AND (OBSTACLE) DEPARTURE PROCEDURES

ORIG 11FEB10 (10042) (FAA)

TAKEOFF OBSTACLE NOTES:

Rwy 18, trees and terrain beginning 50' from DER, 283' left of centerline, up to 35' AGL/201' MSL.

Rwy 36, trees and terrain beginning 12' from DER, 168' left and right of centerline, up to 35' AGL/159' MSL.

COLD BAY, AK

COLD BAY (CDB) (PACD)

TAKEOFF MINIMUMS AND (OBSTACLE) DEPARTURE PROCEDURES

AMDT 9 10SEP20 (20254) (FAA)

TAKEOFF MINIMUMS:

Rwy 26, 900-2% or std. w/min. climb of 400' per NM to 500.

DEPARTURE PROCEDURE:

Rwy 8, climb to 1000 on heading 083° then climbing left turn on course 280° to ELF NDB or to intercept CDB VORTAC R-090 to CDB VORTAC, thence...

Rwy 15, climb to 1000 on heading 146° then climbing left turn on course 315° to ELF NDB or to intercept CDB VORTAC R-135 to CDB VORTAC, thence...

Rwy 26, climbing right turn direct ELF NDB or CDB VORTAC, thence...

CON'T

TAKEOFF MINIMUMS, (OBSTACLE) DEPARTURE PROCEDURES, AND DIVERSE VECTOR AREA (RADAR VECTORS)

24025

TAKEOFF MINIMUMS, (OBSTACLE) DEPARTURE PROCEDURES, AND DIVERSE VECTOR AREA (RADAR VECTORS)

24025

COLD BAY, AK (CON'T)

COLD BAY (CDB) (PAC'D) (CON'T)

Rwy 33, climb direct ELF NDB or CDB VORTAC, thence...

...Aircraft eastbound on G12 continue climb in ELF NDB holding pattern (hold Northwest, left turn, 148° inbound) to 5000 before proceeding on course. All other aircraft continue climb on course to MEA or assigned altitude.

TAKEOFF OBSTACLE NOTES:

Rwy 8, bush 166' from DER, 331' left of centerline, 105' MSL.

Rwy 15, tree 161' from DER, 414' left of centerline, 104' MSL.

Rwy 26, grd beginning 1.5 NM from DER, 2395' left of centerline, up to 461' MSL.

Grd beginning 1.6 NM from DER, 2408' left of centerline, up to 517' MSL.

Grd beginning 1.7 NM from DER, 1928' left of centerline, up to 837' MSL.

Grd beginning 1.8 NM from DER, 1928' left of centerline, up to 871' MSL.

Grd beginning 1.9 NM from DER, 1863' left of centerline, up to 942' MSL.

COLDFOOT, AK

COLDFOOT (CXF) (PACX)

TAKEOFF MINIMUMS AND (OBSTACLE) DEPARTURE PROCEDURES

ORIG-A 20AUG15 (15232) (FAA)

DEPARTURE PROCEDURE:

Use BETTLES DEPARTURE.

CORDOVA, AK

MERLE K (MUDHOLE) SMITH (CDV) (PACV)

TAKEOFF MINIMUMS AND (OBSTACLE) DEPARTURE PROCEDURES

AMDT 8 29MAR18 (18088) (FAA)

TAKEOFF MINIMUMS:

Rwys 16, 34, NA – ATC.

Rwy 27, std. w/min. climb of 283' per NM to 4300.

DEPARTURE PROCEDURE:

Rwy 9, climb to assigned altitude on I-CDV localizer east course to FORAT/I-CDV 44.63 DME before proceeding on course.

Rwy 27, climbing left turn to 5000 on GCR NDB bearing 205° to EYAKS INT and hold (S, right turn, 025° inbound), continue climb-in-hold to 5000 before proceeding on course.

TAKEOFF OBSTACLE NOTES:

Rwy 9, trees and poles beginning 101' from DER, 454' left of centerline, up to 30' AGL/68' MSL.

Rwy 27, trees beginning 15' from DER, 423' left of centerline, up to 30' AGL/84' MSL.

NOTE:

Rwy 9, DME required.

Rwy 27, ADF Required, do not exceed 210K until established on 205° bearing from GCR NDB.

CROOKED CREEK, AK

CROOKED CREEK (CJX) (PACJ)

TAKEOFF MINIMUMS AND (OBSTACLE) DEPARTURE PROCEDURES

ORIG 02DEC21 (21336) (FAA)

TAKEOFF MINIMUMS:

Rwys 14, NA-ATC.

DEPARTURE PROCEDURE:

Rwy 32, use AJOFY DEPARTURE (RNAV).

TAKEOFF OBSTACLE NOTES:

Rwy 32, trees beginning 1643' from DER, 913' right of centerline, up to 278' MSL.

Tree 1875' from DER, 914' right of centerline, 279' MSL.

Trees beginning 1957' from DER, 996' right of centerline, up to 344' MSL.

Trees beginning 2175' from DER, 888' right of centerline, up to 347' MSL.

Trees beginning 2584' from DER, 873' right of centerline, up to 358' MSL.

Tree 2696' from DER, 1019' right of centerline, 363' MSL.

Trees beginning 2786' from DER, 894' right of centerline, up to 365' MSL.

Trees beginning 2811' from DER, 892' right of centerline, up to 390' MSL.

Tree 5058' from DER, 1796' left of centerline, 358' MSL.

Trees beginning 5143' from DER, 1541' left of centerline, up to 379' MSL.

Tree 5256' from DER, 1742' left of centerline, 397' MSL.

Trees beginning 5343' from DER, 1477' left of centerline, up to 414' MSL.

Trees beginning 5405' from DER, 1648' left of centerline, up to 433' MSL.

Trees beginning 5504' from DER, 1437' left of centerline, up to 450' MSL.

Trees beginning 5605' from DER, 1367' left of centerline, up to 464' MSL.

Trees beginning 5762' from DER, 1229' left of centerline, up to 470' MSL.

Trees beginning 5887' from DER, 1624' left of centerline, up to 477' MSL.

Trees, vegetation and terrain beginning 5933' from DER, 1085' left of centerline, up to 501' MSL.

Trees beginning 1.3 NM from DER, 2086' right of centerline, up to 468' MSL.

Trees beginning 1.4 NM from DER, 2171' right of centerline, up to 545' MSL.

Tree 1.6 NM from DER, 2585' left of centerline, 530' MSL.

Tree 1.7 NM from DER, 2727' left of centerline, 562' MSL.

Trees beginning 1.8 NM from DER, 2333' left of centerline, up to 669' MSL.

TAKEOFF MINIMUMS, (OBSTACLE) DEPARTURE PROCEDURES, AND DIVERSE VECTOR AREA (RADAR VECTORS)

24025

TAKEOFF MINIMUMS, (OBSTACLE) DEPARTURE PROCEDURES, AND DIVERSE VECTOR AREA (RADAR VECTORS)

24025

DEADHORSE, AK

DEADHORSE (SCC) (PASC)

TAKEOFF MINIMUMS AND (OBSTACLE) DEPARTURE PROCEDURES

AMDT 3A 12OCT17 (17285) (FAA)

TAKEOFF OBSTACLE NOTES:

Rwy 6, sign 13' from DER, 250' left of centerline, 2' AGL/62' MSL.**Rwy 24**, light 10' from DER, 5' right of centerline, 1' AGL/68' MSL.

DEERING, AK

DEERING (DEE) (PADE)

TAKEOFF MINIMUMS AND (OBSTACLE) DEPARTURE PROCEDURES

AMDT 2 05JAN17 (17005) (FAA)

TAKEOFF MINIMUMS:

Rwy 12, std. w/ min. climb of 350' per NM to 700, or 1100-2½ for climb in visual conditions.

DEPARTURE PROCEDURE:

Rwy 21, climb heading 209° to 600 before turning left.

VCOA:

Rwy 12, for climb in visual conditions, cross Deering airport at or above 1000 before proceeding on course.

TAKEOFF OBSTACLE NOTES:

Rwy 3, vegetation 20' from DER, 138' right of centerline, 23' MSL.

Vegetation 25' from DER, 127' left of centerline, 21' MSL.

Terrain, beginning 68' from DER, 9' right of centerline, up to 37' MSL.

Terrain, beginning 157' from DER, 178' left of centerline, up to 37' MSL.

Pole, terrain, beginning 246' from DER, 17' right of centerline, up to 28' AGL/42' MSL.

Terrain, beginning 397' from DER, 365' left of centerline, up to 40' MSL.

Pole, terrain, beginning 575' from DER, 212' right of centerline, up to 37' AGL/50' MSL.

Rwy 12, terrain 114' from DER, 238' right of centerline, 30' MSL.

Terrain 132' from DER, 153' left of centerline, 30' MSL.

Terrain 5565' from DER, 1138' left of centerline, 165' MSL.

Terrain, beginning 5582' from DER, 255' left of centerline, up to 201' MSL.

Terrain, beginning 5963' from DER, 10' left of centerline, up to 210' MSL.

Terrain, beginning 6002' from DER, 774' right of centerline, up to 181' MSL.

Terrain 1 NM from DER, 1187' left of centerline, 217' MSL.

Terrain, grd, beginning 1 NM from DER, 157' left of centerline, up to 227' MSL.

Terrain, beginning 1 NM from DER, 234' right of centerline, up to 201' MSL.

Terrain 1 NM from DER, 2049' right of centerline, 204' MSL.

Terrain, beginning 1 NM from DER, 87' right of centerline, up to 210' MSL.

Terrain, beginning 1 NM from DER, 60' left of centerline, up to 237' MSL.

Terrain, grd, vegetation, beginning 1 NM from DER, 31' right of centerline, up to 220' MSL.

Terrain, grd, beginning 1.1 NM from DER, 207' left of centerline, up to 243' MSL.

Terrain, vegetation, beginning 1.1 NM from DER, 37' right of centerline, up to 243' MSL.

Terrain, grd, beginning 1.1 NM from DER, 109' left of centerline, up to 253' MSL.

Grd 1.1 NM from DER, 2042' right of centerline, 243' MSL.

Terrain, beginning 1.1 NM from DER, 19' right of centerline, up to 240' MSL.

Terrain, grd, beginning 1.1 NM from DER, 257' left of centerline, up to 260' MSL.

Terrain 1.2 NM from DER, 1312' right of centerline, 253' MSL.

Terrain, beginning 1.2 NM from DER, 12' left of centerline, up to 273' MSL.

Terrain, beginning 1.2 NM from DER, 135' right of centerline, up to 263' MSL.

Grd, terrain, beginning 1.2 NM from DER, 36' right of centerline, up to 274' MSL.

Terrain, grd, beginning 1.2 NM from DER, 159' left of centerline, up to 286' MSL.

Terrain, beginning 1.2 NM from DER, 85' right of centerline, up to 276' MSL.

Terrain, beginning 1.2 NM from DER, 306' left of centerline, up to 306' MSL.

Terrain, grd, beginning 1.3 NM from DER, 23' left of centerline, up to 315' MSL.

Terrain, beginning 1.3 NM from DER, 723' right of centerline, up to 299' MSL.

Grd, terrain, beginning 1.3 NM from DER, 330' right of centerline, up to 305' MSL.

Terrain, grd, beginning 1.3 NM from DER, 14' left of centerline, up to 325' MSL.

Terrain, beginning 1.3 NM from DER, 183' right of centerline, up to 315' MSL.

Terrain, beginning 1.4 NM from DER, 35' right of centerline, up to 315' MSL.

Terrain, grd, beginning 1.4 NM from DER, 280' right of centerline, up to 332' MSL.

Terrain, beginning 1.4 NM from DER, 133' right of centerline, up to 335' MSL.

Terrain, grd, beginning 1.4 NM from DER, 378' right of centerline, up to 352' MSL.

Terrain, grd, beginning 1.5 NM from DER, 5' right of centerline, up to 429' MSL.

Terrain 1.9 NM from DER, 3416' right of centerline, 325' MSL.

Rwy 21, lt, beginning abeam DER, 47' left of centerline, up to 4' AGL/27' MSL.

Lt, REIL ltd, beginning abeam DER, 51' right of centerline, up to 4' AGL/26' MSL.

Terrain, beginning 56' from DER, 62' right of centerline, up to 60' MSL.

Terrain 81' from DER, 515' left of centerline, 40' MSL.

Terrain, beginning 233' from DER, 125' left of centerline, up to 43' MSL.

Terrain, beginning 601' from DER, 265' right of centerline, up to 63' MSL.

Terrain 1539' from DER, 859' right of centerline, 69' MSL.

Terrain, beginning 1932' from DER, 867' right of centerline, up to 86' MSL.

Terrain, beginning 2476' from DER, 883' right of centerline, up to 92' MSL.

Rwy 30, terrain 86' from DER, 299' right of centerline, 40' MSL.

Terrain 104' from DER, 92' left of centerline, 43' MSL.

CON'T

25 JAN 2024 to 21 MAR 2024

25 JAN 2024 to 21 MAR 2024

TAKEOFF MINIMUMS, (OBSTACLE) DEPARTURE PROCEDURES, AND DIVERSE VECTOR AREA (RADAR VECTORS)

24025

AK

TAKEOFF MINIMUMS, (OBSTACLE) DEPARTURE PROCEDURES, AND DIVERSE VECTOR AREA (RADAR VECTORS)

24025

DEERING, AK (CON'T)

DEERING (DEE) (PADE) (CON'T)

Rwy 30 (CON'T), terrain, beginning 122' from DER, 239' left of centerline, up to 46' MSL.

Terrain, beginning 268' from DER, 152' right of centerline, up to 43' MSL.

Terrain, beginning 467' from DER, 5' right of centerline, up to 50' MSL.

Terrain, beginning 648' from DER, 250' right of centerline, up to 60' MSL.

Terrain, beginning 683' from DER, 141' left of centerline, up to 56' MSL.

Terrain, beginning 847' from DER, 103' right of centerline, up to 66' MSL.

Terrain 883' from DER, 288' left of centerline, 66' MSL.

Terrain, beginning 900' from DER, 43' left of centerline, up to 73' MSL.

Terrain, beginning 1046' from DER, 201' right of centerline, up to 69' MSL.

DILLINGHAM, AK

DILLINGHAM (DLG) (PADL)

TAKEOFF MINIMUMS AND (OBSTACLE) DEPARTURE PROCEDURES

AMDT 3 15JAN09 (09015) (FAA)

DEPARTURE PROCEDURE:

Rwy 1, climb on heading between 023° CW to 191° from DER or minimum climb of 265' per NM to 3100' for all other courses.

Rwy 19, climb heading 191° to 800' before turning right.

TAKEOFF OBSTACLE NOTES:

Rwy 1, vehicle on road 191' from DER, left and right, up to 15' AGL/75' MSL.

Multiple trees, poles, fence and antenna 833' from DER, 222' right of centerline, up to 58' AGL/165' MSL.

Multiple trees and poles beginning 1607' from DER, 222' left of centerline, up to 58' AGL/189' MSL.

Rwy 19, building and multiple trees beginning 177' from DER, 191' right of centerline, up to 49' AGL/118' MSL.

Multiple trees, antenna and poles beginning 129' from DER, 234' left of centerline, up to 38' AGL/114' MSL.

EAGLE, AK

EAGLE (EAA) (PAEG)

TAKEOFF MINIMUMS AND (OBSTACLE) DEPARTURE PROCEDURES

ORIG 29MAY14 (14149) (FAA)

TAKEOFF MINIMUMS:

Rwy 7, 4000-3 for climb in visual conditions...

Rwy 25, Std. w/min. climb of 695' to 6700 or 4000-3 for climb in visual conditions...

DEPARTURE PROCEDURE:

Rwy 25, climb heading 266° to 6700 before proceeding on course.

... For climb in visual conditions, cross Eagle Airport at or above 4800 before proceeding on course. When executing VCOA, notify ATC prior to departure.

TAKEOFF OBSTACLE NOTES:

Rwy 7, trees beginning 194' from DER, 222' right of centerline, up to 60' AGL/1024' MSL.

Trees beginning 484' DER, 84' left of centerline, up to 60' AGL/1859' MSL.

Rwy 25, pole 223' from DER, 296' right of centerline, 40' AGL/912' MSL.

Airport beacon 320' from DER, 493' left of centerline, 20' AGL/931' MSL.

Antenna on building 331' from DER, 336' left of centerline, 20' AGL/912' MSL.

Trees beginning 159' from DER, 74' right of centerline, up to 60' AGL/1259' MSL.

Trees beginning 765' from DER, 129' left of centerline, up to 60' AGL/1559' MSL.

EEK, AK

EEK (EEK)

TAKEOFF MINIMUMS AND (OBSTACLE) DEPARTURE PROCEDURES

AMDT 1 10OCT19 (19283) (FAA)

TAKEOFF OBSTACLE NOTES:

Rwy 18, lighting beginning at DER, 40' right of centerline, up to 3' AGL/25' MSL.

Lighting beginning at DER, 41' left of centerline, up to 3' AGL/25' MSL.

Rwy 36, lighting at DER, 40' left of centerline, up to 2' AGL/27' MSL.

EGEGIK, AK

EGEGIK (EII) (PAII)

TAKEOFF MINIMUMS AND (OBSTACLE) DEPARTURE PROCEDURES

ORIG 27AUG09 (09239) (FAA)

TAKEOFF MINIMUMS:

Rwys 3, 21, NA-Environmental.

EIELSON AFB (EIL) (PAEI)

FAIRBANKS, AK

TAKEOFF MINIMUMS AND (OBSTACLE) DEPARTURE PROCEDURES

AMDT 4 25JAN24 (24025) (USAF)

DEPARTURE PROCEDURE:

Rwy 14, std w/min climb gradient of 280'/NM to 3800.

Rwy 32, std w/min climb gradient of 250'/NM to 3800.

CON'T

TAKEOFF MINIMUMS, (OBSTACLE) DEPARTURE PROCEDURES, AND DIVERSE VECTOR AREA (RADAR VECTORS)

24025

AK

TAKEOFF MINIMUMS, (OBSTACLE) DEPARTURE PROCEDURES, AND DIVERSE VECTOR AREA (RADAR VECTORS)

24025

EIELSON AFB (EIL) (PAEI) (CON'T)

FAIRBANKS, AK (CON'T)

TAKEOFF OBSTACLE NOTES:

- Rwy 14**, trees 3607' from DER, 1377' left of centerline, 85' AGL/654' MSL.
Rwy 32, trees 2959' from DER, 1166' right of centerline, 85' AGL/619' MSL.
 Trees 3316' from DER, 1040' left of centerline, 70' AGL/621' MSL.
 Trees 2965' from DER, 1347' right of centerline, 85' AGL/628' MSL.
 Trees 2663' from DER, 1234' right of centerline, 85' AGL/618' MSL.

ELIM, AK

ELIM (ELI) (PFEL)

TAKEOFF MINIMUMS AND (OBSTACLE) DEPARTURE PROCEDURES

ORIG 08APR10 (10098) (FAA)

TAKEOFF MINIMUMS:

Rwy 1, NA-Obstacles.

DEPARTURE PROCEDURE:

Rwy 19, use ELIM (RNAV) DEPARTURE.

ELMENDORF AFB (EDF) (PAED)

ANCHORAGE, AK

TAKEOFF MINIMUMS AND (OBSTACLE) DEPARTURE PROCEDURES

AMDT 1 19MAY22 (22139) (USAF)

TAKEOFF MINIMUMS:

Rwy 16, 1000-3 for climb in visual conditions.

DEPARTURE PROCEDURE:

- Rwy 6**, climb on hdg between 243° CW 358° from der, maintain ATC assigned altitude.
Rwy 16, VCOA: obtain ATC approval for VCOA when requesting IFR clearance. 1000-3 for climb in visual conditions to cross EDF north bound at or above 900, then via EDF R-337 to BAXTE at assigned ATC altitude. Remain within 3 NM of Elmendorf airport during climb in visual conditions.
Rwy 24, climb on hdg between 263° CW 012° from DER, maintain ATC assigned altitude.
Rwy 34, climb on hdg between 182° CW 010° from DER, maintain ATC assigned altitude.

TAKEOFF OBSTACLE NOTES:

- Rwy 6**, terrain at DER, 500' left of cntrln, 209'MSL.
 Terrain at DER, 500' right of cntrln, 207'MSL.
Rwy 16, pylons beginning 3688' from DER, 157' right of cntrln, up to 55' AGL/229' MSL.
 Pylons beginning 3688' from DER, 62' left of cntrln, up to 55' AGL/229' MSL.
Rwy 24, terrain at DER, 500' left of cntrln, 175' MSL.
 Storage container 3557' from DER, 1241' right of cntrln, 283'MSL.
 Terrain beginning 619' from DER, 585' right of cntrln, up to 261' MSL.
Rwy 34, terrain at DER, 172' left of cntrln, 213'MSL.
 Terrain 63' from DER, 517' right of cntrln, 221' MSL.
 Terrain 1683' from DER, 612' right of cntrln, 259' MSL.
 Terrain beginning 1987' from DER, 855' left of cntrln, up to 298' MSL.

DIVERSE VECTOR AREA (RADAR VECTORS)

AMDT 1 24MAY18 (18144) (FAA)

Rwys 6, 24, 34, heading as assigned by ATC.

EMMONAK, AK

EMMONAK (ENM) (PAEM)

TAKEOFF MINIMUMS AND (OBSTACLE) DEPARTURE PROCEDURES

ORIG 15MAR07 (07074) (FAA)

TAKEOFF OBSTACLE NOTES:

Rwy 34, bush 11' from DER, 146' left of centerline, 5' AGL/17' MSL.

FAIRBANKS, AK

FAIRBANKS INTL (FAI) (PAFA)

TAKEOFF MINIMUMS AND (OBSTACLE) DEPARTURE PROCEDURES

AMDT 8 15JUN23 (23166) (FAA)

TAKEOFF MINIMUMS:

- Rwys 2, 2W, 20, 20W**, NA-Environmental.
Rwy 2L, std. w/min. climb of 290' per NM to 2100.
Rwy 2R, std. w/min. climb of 250' per NM to 1900.

DEPARTURE PROCEDURE:

- Rwys 2L/R**, climb on heading 023° to 2000 before turning left.
Rwys 20L/R, climb on heading 203° to 2000 before turning right.

TAKEOFF OBSTACLE NOTES:

- Rwy 20L**, tree, sign beginning 21' from DER, 249' right of centerline, up to 38' AGL/470' MSL.
 Catenary wires, transmission lines, poles and tree beginning 268' from DER, 546' left of centerline, up to 37' AGL/465' MSL.
 Trees beginning 292' from DER, 470' right of centerline, up to 72' AGL/501' MSL.
 Tree 871' from DER, 696' left of centerline, 476' MSL.
 Tree 1026' from DER, 721' left of centerline, 46' AGL/478' MSL.

CON'T

TAKEOFF MINIMUMS, (OBSTACLE) DEPARTURE PROCEDURES, AND DIVERSE VECTOR AREA (RADAR VECTORS)

24025

TAKEOFF MINIMUMS, (OBSTACLE) DEPARTURE PROCEDURES, AND DIVERSE VECTOR AREA (RADAR VECTORS)

24025

FAIRBANKS, AK (CON'T)

FAIRBANKS INTL (FAI) (PAFA) (CON'T)

Rwy 20L (CON'T), trees beginning 1075' from DER, 701' left of centerline, up to 49' AGL/480' MSL.

Tree 1838' from DER, 607' left of centerline, 55' AGL/485' MSL.

Trees beginning 1895' from DER, 130' left of centerline, up to 62' AGL/492' MSL.

Rwy 20R, building, NAVAID beginning 6' from DER, 65' right of centerline, up to 22' AGL/447' MSL.

Tree 1093' from DER, 785' left of centerline, 44' AGL/473' MSL.

Trees beginning 1127' from DER, 789' left of centerline, up to 54' AGL/483' MSL.

Tree 1656' from DER, 943' left of centerline, 61' AGL/489' MSL.

Trees beginning 1798' from DER, 716' right of centerline, up to 66' AGL/492' MSL.

DIVERSE VECTOR AREA (RADAR VECTORS)

AMDT 2 12AUG21 (21224) (FAA)

Rwy 2L, heading as assigned by ATC; requires min. climb of 210' per NM to 1600.

Rwys 2R, 20L/R, heading as assigned by ATC.

FORT YUKON, AK

FORT YUKON (FYU) (PFYU)

TAKEOFF MINIMUMS AND (OBSTACLE) DEPARTURE PROCEDURES

AMDT 2 12DEC13 (13346) (FAA)

TAKEOFF OBSTACLE NOTES:

Rwy 4, terrain 2' from DER, 400' left of centerline, 449' MSL.

Multiple trees and poles beginning 4' from DER, 221' right of centerline, up to 51' AGL/496' MSL.

Bush 63' from DER, 481' left of centerline, 4' AGL/459' MSL.

Multiple trees beginning 251' from DER, 262' left of centerline, up to 45' AGL/494' MSL.

Rwy 22, terrain 27' from DER, 75' right of centerline, 450' MSL.

Windsock 200' from DER, 375' right of centerline, 22' AGL/463' MSL.

Multiple trees and poles beginning 442' from DER, 13' left of centerline, up to 66' AGL/509' MSL.

Trees beginning 72' from DER, 23' right of centerline, up to 67' AGL/507' MSL.

GALENA, AK

EDWARD G PITKA SR (GAL) (PAGA)

TAKEOFF MINIMUMS AND (OBSTACLE) DEPARTURE PROCEDURES

AMDT 1 13SEP18 (18256) (FAA)

TAKEOFF MINIMUMS:

Rwy 6, 24, NA – Environmental.

TAKEOFF OBSTACLE NOTES:

Rwy 8, dam 0' from DER, 198' right of centerline, 37' AGL/165' MSL.

Trees beginning 18' from DER, 298' right of centerline, up to 22' AGL/170' MSL.

Trees, terrain, traverse way beginning 50' from DER, 340' right of centerline, up to 24' AGL/171' MSL.

Tree, dam beginning 232' from DER, 443' right of centerline, up to 18' AGL/177' MSL.

Trees, traverse way beginning 247' from DER, 351' right of centerline, up to 40' AGL/189' MSL.

Trees, traverse way beginning 575' from DER, 179' right of centerline, up to 43' AGL/195' MSL.

Catenary 1439' from DER, 876' left of centerline, 44' AGL/195' MSL.

Rwy 26, NAVAID 26' from DER, 85' right of centerline, 2' AGL/150' MSL.

Tree 55' from DER, 498' left of centerline, 6' AGL/154' MSL.

Traverse way, trees beginning 211' from DER, 499' left of centerline, up to 169' MSL.

Tower, tree beginning 236' from DER, 456' right of centerline, up to 82' AGL/210' MSL.

Trees, traverse way beginning 350' from DER, 339' left of centerline, up to 42' AGL/193' MSL.

Trees beginning 2383' from DER, 851' right of centerline, up to 75' AGL/214' MSL.

GAMBELL, AK

GAMBELL (GAM) (PAGM)

TAKEOFF MINIMUMS AND (OBSTACLE) DEPARTURE PROCEDURES

AMDT 2 08JAN15 (15008) (FAA)

DEPARTURE PROCEDURE:

Rwy 16, climb heading 164° to 700 before turning left.

Rwy 34, climb heading 344° to 700 before turning right.

TAKEOFF OBSTACLE NOTES:

Rwy 34, tower at DER, 178' right of centerline, 22' AGL/42' MSL.

GOLOVIN, AK

GOLOVIN (GLV) (PAGL)

TAKEOFF MINIMUMS AND (OBSTACLE) DEPARTURE PROCEDURES

AMDT 1 13SEP18 (18256) (FAA)

DEPARTURE PROCEDURE:

Use NOME DEPARTURE.

TAKEOFF MINIMUMS, (OBSTACLE) DEPARTURE PROCEDURES, AND DIVERSE VECTOR AREA (RADAR VECTORS)

24025

AK

TAKEOFF MINIMUMS, (OBSTACLE) DEPARTURE PROCEDURES, AND DIVERSE VECTOR AREA (RADAR VECTORS)

24025

GRAYLING, AK

GRAYLING (KGX) (PAGX)

TAKEOFF MINIMUMS AND (OBSTACLE) DEPARTURE PROCEDURES

ORIG 12OCT17 (17285) (FAA)

TAKEOFF MINIMUMS:

Rwy 17, std. w/min. climb of 290' per NM to 1200, or 1700-2½ for VCOA.**Rwy 35**, 800-3 or standard w/min. climb of 390' per NM to 1400, or 1700-2½ for VCOA.

DEPARTURE PROCEDURE:

Rwy 17, climb on a heading between 360° CW 160° from DER to 1200 before proceeding on course.**Rwy 35**, climb on a heading between 360° CW 160° from DER to 1400 before proceeding on course.

VCOA:

Obtain ATC approval for VCOA when requesting IFR clearance. Climb in visual conditions to cross Grayling airport at or above 1700 before proceeding on course.

TAKEOFF OBSTACLE NOTES:

Rwy 17, bush 49' from DER, 397' right of centerline, 6' AGL/150' MSL.

Trees beginning 63' from DER, 336' right of centerline, up to 85' AGL/234' MSL.

Trees beginning 597' from DER, 395' right of centerline, up to 88' AGL/243' MSL.

Tree 655' from DER, 547' right of centerline, 94' AGL/251' MSL.

Trees beginning 1196' from DER, 543' right of centerline, up to 85' AGL/264' MSL.

Trees beginning 1879' from DER, 322' right of centerline, up to 80' AGL/272' MSL.

Trees beginning 2123' from DER, 281' right of centerline, up to 85' AGL/279' MSL.

Trees beginning 2317' from DER, 480' right of centerline, up to 103' AGL/283' MSL.

Trees beginning 4041' from DER, 683' right of centerline, up to 103' AGL/289' MSL.

Trees beginning 4646' from DER, 1031' right of centerline, up to 107' AGL/293' MSL.

Rwy 35, bushes beginning 39' from DER, 155' right of centerline, up to 7' AGL/96' MSL.

Signs beginning 55' from DER, 419' left of centerline, up to 12' AGL/103' MSL.

Tree 747' from DER, 128' right of centerline, 38' AGL/116' MSL.

Trees beginning 812' from DER, 108' right of centerline, up to 52' AGL/133' MSL.

Tree 1116' from DER, 605' left of centerline, 52' AGL/134' MSL.

Trees beginning 1303' from DER, 10' right of centerline, up to 59' AGL/140' MSL.

Trees beginning 1697' from DER, 334' right of centerline, up to 58' AGL/141' MSL.

Tree 1912' from DER, 585' left of centerline, 62' AGL/145' MSL.

Trees beginning 2060' from DER, 210' right of centerline, up to 58' AGL/148' MSL.

Tree 2147' from DER, 345' right of centerline, 58' AGL/150' MSL.

Trees beginning 2257' from DER, 5' right of centerline, up to 62' AGL/152' MSL.

Tree 2383' from DER, 693' left of centerline, 68' AGL/154' MSL.

Trees beginning 2997' from DER, 326' right of centerline, up to 51' AGL/179' MSL.

Tree 3124' from DER, 414' right of centerline, 52' AGL/185' MSL.

Tree 3155' from DER, 1189' left of centerline, 83' AGL/190' MSL.

Trees beginning 3158' from DER, 198' right of centerline, up to 60' AGL/211' MSL.

Trees, tank and tower beginning 3169' from DER, 185' right of centerline, up to 68' AGL/230' MSL.

Trees beginning 3643' from DER, 9' left of centerline, up to 66' AGL/257' MSL.

Trees beginning 1.4 NM from DER, 190' left of centerline, up to 103' AGL/396' MSL.

Trees beginning 1.4 NM from DER, 370' right of centerline, up to 88' AGL/404' MSL.

Trees beginning 1.6 NM from DER, left and right of centerline, up to 93' AGL/588' MSL.

Trees beginning 2.2 NM from DER, left and right of centerline, up to 83' AGL/756' MSL.

Trees beginning 2.4 NM from DER, on centerline, up to 63' AGL/808' MSL.

Trees beginning 2.5 NM from DER, on centerline, up to 53' AGL/848' MSL.

GULKANA, AK

GULKANA (GKN) (PAGK)

TAKEOFF MINIMUMS AND (OBSTACLE) DEPARTURE PROCEDURES

AMDT 8 16JUL20 (22083) (FAA)

TAKEOFF MINIMUMS:

Rwys 15R, 33L, NA-Environmental.

DEPARTURE PROCEDURE:

Rwy 15L, climb on heading 154° to 2800, then climbing left turn direct GKN VOR/DME, thence...**Rwy 33R**, climb on heading 334° to 2800, then climbing left turn direct GKN VOR/DME, thence...

...climb in holding pattern (GKN VOR/DME hold northwest, right turn, 113° inbound), to cross GKN VOR/DME at or above MEA for route of flight.

TAKEOFF OBSTACLE NOTES:

Rwy 15L, tree 263' from DER, 562' left of centerline, 1592' MSL.

Tree 597' from DER, 557' right of centerline, 1610' MSL.

Tree 1144' from DER, 551' left of centerline, 1604' MSL.

Tree 1940' from DER, 490' right of centerline, 1612' MSL.

Trees beginning 1942' from DER, 316' left of centerline, up to 1643' MSL.

Trees beginning 2028' from DER, 377' right of centerline, up to 1618' MSL.

CON'T

TAKEOFF MINIMUMS, (OBSTACLE) DEPARTURE PROCEDURES, AND DIVERSE VECTOR AREA (RADAR VECTORS)

24025

TAKEOFF MINIMUMS, (OBSTACLE) DEPARTURE PROCEDURES, AND DIVERSE VECTOR AREA (RADAR VECTORS)

24025

GULKANA, AK (CON'T)

GULKANA (GKN) (PAGK) (CON'T)

Rwy 33R, tree 227' from DER, 467' right of centerline, 1637' MSL.
Tree 490' from DER, 594' left of centerline, 1660' MSL.
Tree 569' from DER, 570' right of centerline, 1640' MSL.
Tree 709' from DER, 686' right of centerline, 1652' MSL.
Trees beginning 1275' from DER, 495' right of centerline, up to 1663' MSL.
Tree 2613' from DER, 399' left of centerline, 1669' MSL.

GUSTAVUS, AK

GUSTAVUS (GST) (PAGS)

TAKEOFF MINIMUMS AND (OBSTACLE) DEPARTURE PROCEDURES

AMDT 3 27JUN13 (13178) (FAA)

DEPARTURE PROCEDURE:

Use GUSTAVUS DEPARTURE.

HEALY, AK

HEALY RIVER (HRR) (PAHV)

TAKEOFF MINIMUMS AND (OBSTACLE) DEPARTURE PROCEDURES

ORIG 22JUN17 (17173) (FAA)

DEPARTURE PROCEDURE:

Use HEALY DEPARTURE.

HOLY CROSS, AK

HOLY CROSS (HCA) (PAHC)

TAKEOFF MINIMUMS AND (OBSTACLE) DEPARTURE PROCEDURES

AMDT 2 27AUG09 (09239) (FAA)

DEPARTURE PROCEDURE:

Rwy 1, climb heading 013° to 1000 before proceeding on course.

Rwy 19, climb heading 193° to 1000 before proceeding on course.

TAKEOFF OBSTACLE NOTES:

Rwy 1, multiple trees beginning 11' from DER, 163' right of centerline, up to 60' AGL/159' MSL.

Multiple trees beginning 14' from DER, 140' left of centerline, up to 60' AGL/159' MSL.

Rwy 19, multiple trees beginning 21' from DER, 98' right of centerline, up to 60' AGL/159' MSL.

Multiple trees beginning 47' from DER, 117' left of centerline, up to 60' AGL/159' MSL.

HOMER, AK

HOMER (HOM) (PAHO)

TAKEOFF MINIMUMS AND (OBSTACLE) DEPARTURE PROCEDURES

AMDT 3A 20JUN19 (19171) (FAA)

TAKEOFF MINIMUMS:

Rwys 6W, 24W, NA - Environmental.

Rwy 4, std. w/min. climb of 340' per NM to 2000 or 3800-3 for VCOA.

DEPARTURE PROCEDURE:

Rwy 4, climb on heading 038° to 2000, then climbing right turn heading 240° to intercept and track outbound on HOM VOR/DME R-210 thence . . .

Rwy 22, climbing right turn heading 245° to intercept HOM VOR/DME R-210 thence . . .

. . . northeast through southwest bound (020 CW 210) climb to 2600 on HOM VOR/DME R-210 then right turn direct HOM

VOR/DME cross HOM VOR/DME at or above 4000, then climb on course.

. . . southwest through northeast bound (211 CW 019) climb to 2600 on HOM VOR/DME R-210 outbound then climb on course.

VCOA:

Rwy 4, obtain ATC approval for VCOA when requesting IFR clearance: climb in visual conditions to cross Homer airport at or above 3700 before proceeding on course.

TAKEOFF OBSTACLE NOTES:

Rwy 4, terrain 7' from DER, 421' right of centerline, 91' MSL.

Vegetation, lighting, terrain beginning 9' from DER, 4' right of centerline, up to 95' MSL.

Lighting 11' from DER, 5' left of centerline, 2' AGL/75' MSL.

Wind indicator 223' from DER, 329' right of centerline, 19' AGL/108' MSL.

Pole, NAVAID beginning 224' from DER, 196' right of centerline, up to 20' AGL/109' MSL.

Tree 1381' from DER, 527' right of centerline, 128' MSL.

Tree 1939' from DER, 599' right of centerline, 131' MSL.

Trees beginning 1965' from DER, 347' right of centerline, up to 136' MSL.

Trees beginning 2170' from DER, 335' right of centerline, up to 142' MSL.

Trees beginning 2246' from DER, 418' right of centerline, up to 149' MSL.

Trees beginning 2376' from DER, 907' right of centerline, up to 166' MSL.

Trees beginning 2528' from DER, 767' right of centerline, up to 188' MSL.

Rwy 22, fence, lighting, sign beginning 3' from DER, 5' left of centerline, up to 9' AGL/80' MSL.

Lighting 10' from DER, 5' right of centerline, 2' AGL/72' MSL.

Tree 307' from DER, 532' left of centerline, 126' MSL.

NAVAID, pole beginning 522' from DER, 518' right of centerline, up to 36' AGL/104' MSL.

Tower 1035' from DER, 702' right of centerline, 62' AGL/130' MSL.

TAKEOFF MINIMUMS, (OBSTACLE) DEPARTURE PROCEDURES, AND DIVERSE VECTOR AREA (RADAR VECTORS)

24025

TAKEOFF MINIMUMS, (OBSTACLE) DEPARTURE PROCEDURES, AND DIVERSE VECTOR AREA (RADAR VECTORS)

24025

HOOPER BAY, AK

HOOPER BAY (HPB) (PAHP)

TAKEOFF MINIMUMS AND (OBSTACLE) DEPARTURE PROCEDURES

AMDT 1 08SEP22 (22251) (FAA)

TAKEOFF OBSTACLE NOTES:

- Rwy 14**, lighting beginning 9' from DER, 16' left of centerline, up to 2' AGL/20' MSL.
- Lighting beginning 9' from DER, 17' right of centerline, up to 2' AGL/20' MSL.
- Vehicle on road beginning 96' from DER, on centerline, up to 28' MSL.
- Building 130' from DER, 379' left of centerline, 18' AGL/24' MSL.
- Vehicle on road beginning 336' from DER, 28' left of centerline, up to 28' MSL.
- Pole, catenary beginning 451' from DER, 400' left of centerline, up to 14' AGL/40' MSL.
- General utility 589' from DER, 389' left of centerline, 16' AGL/42' MSL.
- Antennas beginning 592' from DER, 388' left of centerline, up to 34' AGL/46' MSL.
- Rwy 32**, lighting 9' from DER, 37' right of centerline, 2' AGL/21' MSL.
- Lighting 10' from DER, 47' left of centerline, 2' AGL/21' MSL.

HUGHES, AK

HUGHES (HUS) (PAHU)

TAKEOFF MINIMUMS AND (OBSTACLE) DEPARTURE PROCEDURES

ORIG 02DEC21 (21336) (FAA)

DEPARTURE PROCEDURE:

Use HUGHES (RNAV) DEPARTURE.

TAKEOFF OBSTACLE NOTES:

- Rwy 18**, tree 5' from DER, 205' right of centerline, 32' AGL/324' MSL.
- Trees beginning 13' from DER, 150' right of centerline, up to 41' AGL/332' MSL.
- Trees beginning 36' from DER, 176' left of centerline, up to 59' AGL/350' MSL.
- Trees beginning 161' from DER, 244' left of centerline, up to 61' AGL/352' MSL.
- Tree 187' from DER, 471' left of centerline, 61' AGL/354' MSL.
- Trees beginning 235' from DER, 64' left of centerline, up to 65' AGL/358' MSL.
- Trees beginning 510' from DER, 187' left of centerline, up to 68' AGL/362' MSL.
- Tree 1484' from DER, 855' right of centerline, 51' AGL/347' MSL.
- Tree 1886' from DER, 561' right of centerline, 54' AGL/350' MSL.
- Tree 2187' from DER, 325' right of centerline, 54' AGL/353' MSL.
- Trees beginning 2199' from DER, 106' right of centerline, up to 64' AGL/364' MSL.
- Tree 2510' from DER, 16' left of centerline, 72' AGL/365' MSL.
- Trees beginning 2524' from DER, 52' right of centerline, up to 68' AGL/370' MSL.
- Trees beginning 2626' from DER, 168' right of centerline, up to 76' AGL/377' MSL.
- Tree 2664' from DER, 7' left of centerline, 81' AGL/375' MSL.
- Trees beginning 2666' from DER, 225' right of centerline, up to 78' AGL/379' MSL.
- Rwy 36**, trees, vehicles on road beginning 1' from DER, 345' right of centerline, up to 28' AGL/322' MSL.
- Vegetation 42' from DER, 123' left of centerline, 5' AGL/301' MSL.
- Trees beginning 76' from DER, 90' left of centerline, up to 35' AGL/318' MSL.
- Trees, vehicles on road beginning 77' from DER, 86' right of centerline, up to 31' AGL/328' MSL.
- Poles, trees, catenary, vehicles on road, antenna, buildings, vertical structures beginning 105' from DER, 117' right of centerline, up to 34' AGL/331' MSL.
- Trees beginning 138' from DER, 142' left of centerline, up to 44' AGL/337' MSL.
- Trees beginning 294' from DER, 132' left of centerline, up to 46' AGL/340' MSL.
- Tree, vehicles on road beginning 360' from DER, 482' right of centerline, up to 47' AGL/344' MSL.
- Trees beginning 415' from DER, 528' right of centerline, up to 49' AGL/346' MSL.
- Trees, vehicles on road, buildings, vertical structures, poles, lighting, tower, catenary, antenna beginning 448' from DER, 198' right of centerline, up to 51' AGL/348' MSL.
- Trees, poles, catenary beginning 1012' from DER, 277' right of centerline, up to 48' AGL/403' MSL.
- Trees beginning 1203' from DER, 568' right of centerline, up to 63' AGL/511' MSL.
- Trees beginning 1415' from DER, 275' right of centerline, up to 52' AGL/553' MSL.
- Tree 1573' from DER, 760' right of centerline, 54' AGL/587' MSL.
- Trees beginning 1599' from DER, 394' right of centerline, up to 50' AGL/595' MSL.
- Trees beginning 1780' from DER, 314' right of centerline, up to 52' AGL/607' MSL.
- Trees beginning 1823' from DER, 316' right of centerline, up to 53' AGL/611' MSL.
- Trees beginning 2200' from DER, 356' right of centerline, up to 54' AGL/630' MSL.
- Tree 2.1 NM from DER, 3729' right of centerline, 18' AGL/627' MSL.

HUSLIA, AK

HUSLIA (HLA) (PAHL)

TAKEOFF MINIMUMS AND (OBSTACLE) DEPARTURE PROCEDURES

ORIG 25SEP08 (08269) (FAA)

TAKEOFF OBSTACLE NOTES:

- Rwy 3**, multiple trees beginning 115' from DER, 278' right of centerline, up to 20' AGL/261' MSL.
- Multiple trees beginning 181' from DER, 20' left of centerline, up to 20' AGL/275' MSL.
- Rwy 21**, pole 1125' from DER, 795' right of centerline, 76' AGL/260' MSL.
- Multiple trees and bushes beginning 169' from DER, 164' left of centerline, up to 20' AGL/284' MSL.
- Multiple trees and bushes beginning 141' from DER, 204' right of centerline, up to 20' AGL/260' MSL.

TAKEOFF MINIMUMS, (OBSTACLE) DEPARTURE PROCEDURES, AND DIVERSE VECTOR AREA (RADAR VECTORS)

24025

TAKEOFF MINIMUMS, (OBSTACLE) DEPARTURE PROCEDURES, AND DIVERSE VECTOR AREA (RADAR VECTORS)

24025

IGIUGIG, AK

IGIUGIG (IGG) (PAIG)

TAKEOFF MINIMUMS AND (OBSTACLE) DEPARTURE PROCEDURES

ORIG 15JAN09 (09015) (FAA)

TAKEOFF OBSTACLE NOTES:

Rwy 5, trees beginning 13' from DER, 154' right of centerline, up to 60' AGL/159' MSL.**Rwy 23**, trees beginning 13' from DER, 153' left of centerline, up to 60' AGL/209' MSL.

ILIAMNA, AK

ILIAMNA (ILI) (PAIL)

TAKEOFF MINIMUMS AND (OBSTACLE) DEPARTURE PROCEDURES

AMDT 2A 13SEP18 (18256) (FAA)

TAKEOFF MINIMUMS:

Rwy 36, std. w/min. climb of 400' per NM to 2900, or 3000 - 3 for climb in visual conditions.

DEPARTURE PROCEDURE:

Rwy 8, climb to 2100, then climbing right turn via 281° bearing to ILI NDB. Climb in ILI NDB/DME holding pattern (south, right turn, 006° inbound) to 4500 before proceeding enroute.**Rwy 18**, climb to 2100, then climbing left turn via 331° bearing to ILI NDB. Climb in ILI NDB/DME holding pattern (south, right turn, 006° inbound) to 4500 before proceeding enroute.**Rwy 26**, climb heading 243° to 2100, then climbing left turn via 044° bearing to ILI NDB. Climb in ILI NDB/DME holding pattern (south, right turn, 006° inbound) to 4500 before proceeding enroute.**Rwy 36**, climb to 2900, then climbing left turn via 141° bearing to ILI NDB. Climb in ILI NDB/DME holding pattern (south, right turn, 006° inbound) to 4500 before proceeding enroute.

VCOA:

Cross Iliamna airport at or above 2900 MSL before proceeding on course.

TAKEOFF OBSTACLE NOTES:

Rwy 8, WSK 1' from DER, 358' left of centerline, 16' AGL/160' MSL.

Tree 304' from DER, 363' left of centerline, 11' AGL/155' MSL

Rwy 18, trees beginning 59' from DER, 442' right of centerline, up to 30' AGL/199' MSL.**Rwy 26**, trees beginning 76' from DER, 211' right of centerline, up to 30' AGL/262' MSL.

Trees beginning 208' from DER, 12' left of centerline, up to 30' AGL/263' MSL.

Rwy 36, trees beginning 85' from DER, 18' left of centerline, up to 30' AGL/239' MSL.

Trees beginning 757' from DER, 39' right of centerline, up to 30' AGL/238' MSL.

Bushes beginning 247' from DER, 281' left of centerline, up to 30' AGL/205' MSL.

Bush 434' from DER, 258' right of centerline, 11' AGL/194' MSL.

Vehicle on road 436' from DER, 407' left of centerline, up to 15' AGL/219' MSL.

INDIAN MOUNTAIN LRRS (UTO) (PAIM)

UTOPIA CREEK, AK

TAKEOFF MINIMUMS AND (OBSTACLE) DEPARTURE PROCEDURES

AMDT 1 03NOV22 (23222) (USAF)

TAKEOFF MINIMUMS:

Rwy 6, 3400-3 for climb in visual conditions.**Rwy 24**, NA.

DEPARTURE PROCEDURE:

Diverse departures NA.

CAUTION: Uncontrolled airspace below 700' AGL within 4 NM of Indian Mountain LRRS airport.

Rwy 6, obtain ATC approval for VCOA when requesting IFR clearance. Climb in visual conditions to cross Indian Mountain LRRS at or above 4500' MSL before proceeding on course. Remain within 3 NM of Indian Mountain LRRS during climb in visual conditions.

TAKEOFF OBSTACLE NOTES:

Rwy 6, terrain 888' from DER, 738' right of centerline, 1004' MSL.

Terrain 634' from DER, 670' right of centerline, 1012' MSL.

Terrain 885' from DER, 644' right of centerline, 994' MSL.

Terrain 153' from DER, 509' right of centerline, 994' MSL.

Terrain abeam the DER, 287' right of centerline, 962' MSL.

Terrain 380' from DER, 602' right of centerline, 1007' MSL.

Terrain 4836' from DER, 1796' left of centerline, 1112' MSL.

Terrain 887' from DER, 738' right of centerline, 1004' MSL.

JUNEAU, AK

JUNEAU INTL (JNU) (PAJN)

TAKEOFF MINIMUMS AND (OBSTACLE) DEPARTURE PROCEDURES

AMDT 4 22AUG13 (13234) (FAA)

DEPARTURE PROCEDURE:

Rwys 8, 26, Use JUNEAU DEPARTURE.

KAKE, AK

KAKE (AFE) (PAFE)

TAKEOFF MINIMUMS AND (OBSTACLE) DEPARTURE PROCEDURES

AMDT 1 31JUL08 (08213) (FAA)

DEPARTURE PROCEDURE:

Use KAKE DEPARTURE.

TAKEOFF MINIMUMS, (OBSTACLE) DEPARTURE PROCEDURES, AND DIVERSE VECTOR AREA (RADAR VECTORS)

24025

TAKEOFF MINIMUMS, (OBSTACLE) DEPARTURE PROCEDURES, AND DIVERSE VECTOR AREA (RADAR VECTORS)

24025

KALSKAG, AK

KALSKAG (KLG) (PALG)

TAKEOFF MINIMUMS AND (OBSTACLE) DEPARTURE PROCEDURES
AMDT 2 08SEP22 (22251) (FAA)

TAKEOFF MINIMUMS:

Rwy 7, NA-Environmental.

DEPARTURE PROCEDURE:

Rwy 25, climb on heading 251° to 1000 before proceeding on course.

TAKEOFF OBSTACLE NOTES:

Rwy 25, pole, vegetation beginning 5' from DER, 273' right of centerline, up to 86' MSL.

Wind indicator 11' from DER, 251' left of centerline, 73' MSL.

Trees, pole beginning 52' from DER, 194' left of centerline, up to 71' AGL/126' MSL.

Trees, poles beginning 249' from DER, 445' right of centerline, up to 115' MSL.

Trees, poles beginning 487' from DER, 423' left of centerline, up to 127' MSL.

Trees, pole beginning 929' from DER, 17' right of centerline, up to 124' MSL.

Trees, pole beginning 1099' from DER, 19' left of centerline, up to 70' AGL/131' MSL.

KALTAG, AK

KALTAG (KAL) (PAKV)

TAKEOFF MINIMUMS AND (OBSTACLE) DEPARTURE PROCEDURES
ORIG-A 05JAN17 (17005) (FAA)

TAKEOFF MINIMUMS:

Rwy 3, std. w/min. climb of 460' per NM to 4000, or 3000-3 for VCOA.**Rwy 21**, std. w/min. climb of 481' per NM to 4000, or 3000-3 for VCOA.

DEPARTURE PROCEDURE:

Rwy 3, climb heading 029° to 1100 before proceeding on course.**Rwy 21**, climb heading 209° to 1100 before proceeding on course.

VCOA:

Obtain ATC approval for VCOA when requesting IFR clearance. Climb in visual conditions to cross Kaltag airport at or above 3000 before proceeding on course.

TAKEOFF OBSTACLE NOTES:

Rwy 3, trees beginning 786' from DER, crossing centerline, 221' MSL.

Vehicle on road 809' from DER, 349' right of centerline, 192' MSL.

Tower 1319' from DER, 529' right of centerline, 130' AGL/240' MSL.

Rwy 21, bush 81' from DER, 463' left of centerline, 196' MSL.

Trees beginning 628' from DER, 593' right of centerline, up to 277' MSL.

Trees beginning 1915' from DER, 449' left of centerline up to 288' MSL.

Trees beginning 2777' from DER, 329' left of centerline, up to 308' MSL.

Trees beginning 3732' from DER, 134' left of centerline, up to 308' MSL.

Tree 4872' from DER, 244' right of centerline, 304' MSL.

KASIGLUK, AK

KASIGLUK (Z09) (PFKA)

TAKEOFF MINIMUMS AND (OBSTACLE) DEPARTURE PROCEDURES
ORIG 22AUG13 (13234) (FAA)

DEPARTURE PROCEDURE:

Rwy 17, climb heading 174° to 800 before proceeding on course.

TAKEOFF OBSTACLE NOTES:

Rwy 35, bush 13' from DER, 52' left of centerline, 6' AGL/31' MSL.

KENAI, AK

KENAI MUNI (ENA) (PAEN)

TAKEOFF MINIMUMS AND (OBSTACLE) DEPARTURE PROCEDURES
AMDT 2A 13SEP18 (18256) (FAA)

TAKEOFF MINIMUMS:

Rwys 2W, 20W, NA- Environmental.

DEPARTURE PROCEDURE:

Rwys 2L/R, climb on a heading between 304° clockwise to 196° from DER.**Rwys 20L/R**, climb heading 196° to 1100, then climb on a heading between 226° counter clockwise to 016° from DER.

TAKEOFF OBSTACLE NOTES:

Rwy 2L, sign 20' from DER, 122' right of centerline, 4' AGL/100' MSL.

Windsock 523' from DER, 599' left of centerline, 20' AGL/120' MSL.

Rwy 2R, trees and catenary beginning 533' from DER, 262' right of centerline, up to 39' AGL/137' MSL.**Rwy 20L**, trees beginning 900' from DER, 524' left of centerline, up to 50' AGL/141' MSL.

Control tower and antenna on control tower beginning 2060' from DER, 675' left of centerline, up to 79' AGL/174' MSL.

Tree 2998' from DER, 1050' left of centerline, 108' AGL/198' MSL.

Rwy 20R, vehicle on road 9' from DER, 497' right of centerline, 15' AGL/117' MSL.

Trees beginning 599' from DER, 354' right of centerline, up to 76' AGL/153' MSL.

DME antenna and trees beginning 821' from DER, 103' left of centerline, up to 34' AGL/119' MSL.

TAKEOFF MINIMUMS, (OBSTACLE) DEPARTURE PROCEDURES, AND DIVERSE VECTOR AREA (RADAR VECTORS)

24025

TAKEOFF MINIMUMS, (OBSTACLE) DEPARTURE PROCEDURES, AND DIVERSE VECTOR AREA (RADAR VECTORS)

24025

KETCHIKAN, AK

KETCHIKAN INTL (KTN) (PAKT)

TAKEOFF MINIMUMS AND (OBSTACLE) DEPARTURE PROCEDURES

AMDT 9 19JUL18 (18200) (FAA)

DEPARTURE PROCEDURE:

Rwy 11, use KETCHIKAN DEPARTURE.

Rwy 29, use SKOWL DEPARTURE.

TAKEOFF OBSTACLE NOTES:

Rwy 11, electrical system 5' from DER, 55' left of centerline, 1' AGL/90' MSL.

Electrical system 5' from DER, 54' right of centerline, 1' AGL/90' MSL.

Tree 107' from DER, 514' left of centerline, 93' MSL.

Tree 190' from DER, 508' left of centerline, 76' AGL/95' MSL.

Tree 483' from DER, 572' right of centerline, 126' MSL.

Tree 966' from DER, 692' right of centerline, 128' MSL.

Tree 1072' from DER, 693' right of centerline, 144' MSL.

Trees beginning 1195' from DER, 659' right of centerline, up to 154' MSL.

Tree 2469' from DER, 1001' right of centerline, 164' MSL.

Tree 2567' from DER, 1060' right of centerline, 168' MSL.

Trees beginning 2768' from DER, 1014' right of centerline, up to 173' MSL.

Rwy 29, trees beginning 428' from DER, 549' left of centerline, up to 121' MSL.

Trees beginning 671' from DER, 572' left of centerline, up to 135' MSL.

Tree 2370' from DER, 1093' left of centerline, 147' MSL.

Tree 2728' from DER, 989' left of centerline, 154' MSL.

Trees beginning 2787' from DER, 1089' left of centerline, up to 164' MSL.

Tree 3059' from DER, 1264' left of centerline, 188' MSL.

Trees beginning 3195' from DER, 971' left of centerline, up to 194' MSL.

Trees beginning 3558' from DER, 1125' left of centerline, up to 220' MSL.

Trees beginning 3658' from DER, 1243' left of centerline, up to 234' MSL.

Trees beginning 3754' from DER, 840' left of centerline, up to 238' MSL.

Trees beginning 5550' from DER, 1591' left of centerline, up to 250' MSL.

Tree 6050' from DER, 1934' left of centerline, 252' MSL.

Trees beginning 6070' from DER, 1883' left of centerline, up to 284' MSL.

Tree 1.9 NM from DER, 3275' left of centerline, 390' MSL.

Tree 2 NM from DER, 3284' left of centerline, 415' MSL.

Tree 2 NM from DER, 3381' left of centerline, 462' MSL.

Tree 2.2 NM from DER, 4085' left of centerline, 100' AGL/576' MSL.

Trees beginning 2.2 NM from DER, 2371' left of centerline, up to 607' MSL.

Trees beginning 2.3 NM from DER, 3644' left of centerline, up to 100' AGL/622' MSL.

Trees beginning 2.3 NM from DER, 2461' left of centerline, up to 640' MSL.

Trees beginning 2.3 NM from DER, 2432' left of centerline, up to 647' MSL.

Tree 2.3 NM from DER, 4153' left of centerline, 100' AGL/658' MSL.

Trees beginning 2.3 NM from DER, 2171' left of centerline, up to 783' MSL.

Trees beginning 2.4 NM from DER, 2456' left of centerline, up to 866' MSL.

KIANA, AK

BOB BAKER MEML (IAN) (PAIK)

TAKEOFF MINIMUMS AND (OBSTACLE) DEPARTURE PROCEDURES

AMDT 1 31DEC20 (21112) (FAA)

TAKEOFF MINIMUMS:

Rwy 25, NA - Terrain.

DEPARTURE PROCEDURE:

Rwy 7, Use SELAWIK (RNAV) DEPARTURE.

TAKEOFF OBSTACLE NOTES:

Rwy 7, trees beginning 36' from DER, 171' left of centerline, up to 23' AGL/157' MSL.

Tree 425' from DER, 595' left of centerline, 24' AGL/161' MSL.

Trees beginning 477' from DER, 474' left of centerline, up to 30' AGL/166' MSL.

Tree 488' from DER, 601' left of centerline, 29' AGL/168' MSL.

Trees beginning 522' from DER, 411' left of centerline, up to 34' AGL/169' MSL.

Tree 581' from DER, 576' left of centerline, 31' AGL/170' MSL.

Trees beginning 590' from DER, 434' left of centerline, up to 36' AGL/171' MSL.

Trees beginning 601' from DER, 520' left of centerline, up to 35' AGL/172' MSL.

Trees beginning 623' from DER, 438' left of centerline, up to 40' AGL/174' MSL.

25 JAN 2024 to 21 MAR 2024

25 JAN 2024 to 21 MAR 2024

TAKEOFF MINIMUMS, (OBSTACLE) DEPARTURE PROCEDURES, AND DIVERSE VECTOR AREA (RADAR VECTORS)

24025

AK

TAKEOFF MINIMUMS, (OBSTACLE) DEPARTURE PROCEDURES, AND DIVERSE VECTOR AREA (RADAR VECTORS)

24025

KING COVE, AK

KING COVE (KVC) (PAVC)

TAKEOFF MINIMUMS AND (OBSTACLE) DEPARTURE PROCEDURES

AMDT 1 31DEC20 (20366) (FAA)

TAKEOFF MINIMUMS:

Rwy 26, NA - Obstacles.

DEPARTURE PROCEDURE:

Rwy 8, use COLD BAY (RNAV) DEPARTURE.

TAKEOFF OBSTACLE NOTES:

Rwy 8, fence, tree, vegetation beginning 14' from DER, 77' left of centerline, up to 8' AGL/154' MSL.

Tree 20' from DER, 286' right of centerline, 8' AGL/145' MSL.

Trees beginning 26' from DER, 163' right of centerline, up to 12' AGL/153' MSL.

Fence 72' from DER, 385' left of centerline, 8' AGL/158' MSL.

Tree, building, general utility beginning 99' from DER, 252' left of centerline, up to 11' AGL/167' MSL.

Fence 129' from DER, 383' left of centerline, 10' AGL/168' MSL.

Trees, fences, vegetation beginning 145' from DER, 361' left of centerline, up to 10' AGL/175' MSL.

KING SALMON, AK

KING SALMON (AKN) (PAKN)

TAKEOFF MINIMUMS AND (OBSTACLE) DEPARTURE PROCEDURES

AMDT 1 25SEP08 (08269) (FAA)

TAKEOFF OBSTACLE NOTES:

Rwy 12, trees beginning 549' from DER, 353' left of centerline, up to 30' AGL/108' MSL.**Rwy 36**, trees beginning 750' from DER, 265' left of centerline, up to 30' AGL/93' MSL.

Bush and trees beginning 59' from DER, 180' right of centerline, up to 30' AGL/87' MSL.

KIPNUK, AK

KIPNUK (IIK) (PAKI)

TAKEOFF MINIMUMS AND (OBSTACLE) DEPARTURE PROCEDURES

AMDT 2 01FEB18 (18032) (FAA)

TAKEOFF OBSTACLE NOTES:

Rwy 17, rwy light beginning 9' from DER, 40' right of centerline, up to 2' AGL/20' MSL.

Rwy light beginning 9' from DER, 51' left of centerline, up to 3' AGL/20' MSL.

Rwy light 10' from DER, 40' left of centerline, 3' AGL/21' MSL.

Rwy 35, segmented circle marker, rwy light beginning 0' from DER, 40' left of centerline, up to 6' AGL/20' MSL.

Rwy light beginning 9' from DER, 40' right of centerline, up to 2' AGL/20' MSL.

KIVALINA, AK

KIVALINA (KVL) (PAVL)

TAKEOFF MINIMUMS AND (OBSTACLE) DEPARTURE PROCEDURES

ORIG-A 15OCT15 (15288) (FAA)

TAKEOFF OBSTACLE NOTES:

Rwy 12, windsock 143' from DER, 267' left of centerline, 22' AGL/30' MSL.

Tower 3544' from DER, 150' left of centerline, 100' AGL/115' MSL.

Rwy 30, bush 2' from DER, 82' left of centerline, 2' AGL/18' MSL.

Bush 16' from DER, 85' left of centerline, 2' AGL/18' MSL.

KLAWOCK, AK

KLAWOCK (AKW) (PAKW)

TAKEOFF MINIMUMS AND (OBSTACLE) DEPARTURE PROCEDURES

AMDT 4A 05DEC19 (19339) (FAA)

TAKEOFF MINIMUMS:

Rwy 2, NA - Obstacles

DEPARTURE PROCEDURE:

Rwy 20, use KLAWOCK DEPARTURE.

TAKEOFF OBSTACLE NOTES:

Rwy 20, trees 5964' from DER, 1369' left of centerline, up to 158' AGL/357' MSL.

25 JAN 2024 to 21 MAR 2024

25 JAN 2024 to 21 MAR 2024

TAKEOFF MINIMUMS, (OBSTACLE) DEPARTURE PROCEDURES, AND DIVERSE VECTOR AREA (RADAR VECTORS)

24025

AK

TAKEOFF MINIMUMS, (OBSTACLE) DEPARTURE PROCEDURES, AND DIVERSE VECTOR AREA (RADAR VECTORS)

24025

KOBUK, AK

KOBUK (OBU) (PAOB)

TAKEOFF MINIMUMS AND (OBSTACLE) DEPARTURE PROCEDURES

ORIG 20DEC07 (07354) (FAA)

TAKEOFF MINIMUMS:

Rwy 27, 300-1 or std. w/ a min. climb of 661' per NM to 400.

DEPARTURE PROCEDURE:

Rwy 9, climbing right turn via heading 220° and AMF NDB 283° course to AMF NDB before proceeding on course.**Rwy 27**, climb via heading 267° and AMF NDB 283° course to AMF NDB before proceeding on course.

TAKEOFF OBSTACLE NOTES:

Rwy 9, multiple trees beginning 169' from DER, 36' right of centerline, up to 50' AGL/199' MSL.

Multiple trees beginning 231' from DER, 385' left of centerline, up to 50' AGL/199' MSL.

Rwy 27, multiple trees beginning 79' from DER, 220' left of centerline, up to 50' AGL/182' MSL.

Multiple trees beginning 17' from DER, 299' right of centerline, up to 50' AGL/249' MSL.

KODIAK, AK

KODIAK (ADQ) (PADQ)

TAKEOFF MINIMUMS AND (OBSTACLE) DEPARTURE PROCEDURES

AMDT 4 15OCT15 (15288) (FAA)

TAKEOFF MINIMUMS:

Rwy 26, NA-terrain.

DEPARTURE PROCEDURE:

Rwys 1, 8, 11, 19, 29, use KODIAK DEPARTURE.

KOKHANOK, AK

KOKHANOK (9K2) (PFFK)

TAKEOFF MINIMUMS AND (OBSTACLE) DEPARTURE PROCEDURES

AMDT 1 19JUL18 (18200) (FAA)

TAKEOFF MINIMUMS:

Rwy 7, 400-1¾.

DEPARTURE PROCEDURE:

Rwy 7, climbing left turn direct ILI NDB/DME, continue climb in ILI NDB/DME holding pattern (hold south, right turns, 006° inbound) to cross ILI NDB/DME at or above mea for route of flight.**Rwy 25**, climbing right turn direct ILI NDB/DME, continue climb in ILI NDB/DME holding pattern (hold south, right turns, 006° inbound) to cross ILI NDB/DME at or above MEA for route of flight.

TAKEOFF OBSTACLE NOTES:

Rwy 7, tree 13' from DER, 160' right of centerline, 80' AGL/215' MSL.

Trees beginning 542' from DER, 464' right of centerline, up to 80' AGL/230' MSL.

Tree 1694' from DER, 111' left of centerline, 80' AGL/230' MSL.

Trees beginning 1844' from DER, 545' right of centerline, up to 80' AGL/280' MSL.

Tree 3579' from DER, 889' right of centerline, 80' AGL/290' MSL.

Trees beginning 4350' from DER, 651' right of centerline, up to 80' AGL/303' MSL.

Tree 1.3 NM from DER, 2012' right of centerline, 80' AGL/434' MSL.

Rwy 25, trees beginning 12' from DER, 127' right of centerline, up to 80' AGL/180' MSL.

Tree 113' from DER, 346' left of centerline, 80' AGL/188' MSL.

Trees beginning 1792' from DER, 268' left of centerline, up to 80' AGL/205' MSL.

KOLIGANEK, AK

KOLIGANEK (JZZ) (PAJZ)

TAKEOFF MINIMUMS AND (OBSTACLE) DEPARTURE PROCEDURES

AMDT 3 20AUG15 (15232) (FAA)

DEPARTURE PROCEDURE:

Rwy 9, climb heading 093° to 900 before turning North.**Rwy 27**, climb heading 273° to 1500 before turning North.

TAKEOFF OBSTACLE NOTES:

Rwy 9, multiple bushes beginning 50' from DER, 15' right of centerline, up to 15' AGL/327' MSL.

Multiple bushes beginning 180' from DER, 69' left of centerline, up to 15' AGL/340' MSL.

Rwy 27, multiple bushes beginning 76' from DER, 146' left and right of centerline, up to 15' AGL/271' MSL.

Power pole 845' from DER, 716' right of centerline, 50' AGL/267' MSL.

TAKEOFF MINIMUMS, (OBSTACLE) DEPARTURE PROCEDURES, AND DIVERSE VECTOR AREA (RADAR VECTORS)

24025

AK

TAKEOFF MINIMUMS, (OBSTACLE) DEPARTURE PROCEDURES, AND DIVERSE VECTOR AREA (RADAR VECTORS)

24025

KOTLIK, AK

KOTLIK (2A9) (PFKO)

TAKEOFF MINIMUMS AND (OBSTACLE) DEPARTURE PROCEDURES

AMDT1 10NOV16 (16315) (FAA)

TAKEOFF OBSTACLE NOTES:

Rwy 02, tree abeam DER, 182' right of centerline, 6' AGL/16' MSL.
Vehicle on road 3' from DER, 183' left of centerline, 23' MSL.
Tree 58' from DER, 111' right of centerline, 8' AGL/18' MSL.
Pole 84' from DER, 76' left of centerline, 26' AGL/37' MSL.
Tree 137' from DER, 233' right of centerline, 16' AGL/21' MSL.
Tree 171' from DER, 154' right of centerline, 13' AGL/23' MSL.
Tree 324' from DER, 181' right of centerline, 15' AGL/24' MSL.
Tree 606' from DER, 221' right of centerline, 24' AGL/30' MSL.
Rwy 20, bush 8' from DER, 105' left of centerline, 5' AGL/14' MSL.
Tree 24' from DER, 132' right of centerline, 10' AGL/16' MSL.

KOTZEBUE, AK

RALPH WIEN MEML (OTZ) (PAOT)

TAKEOFF MINIMUMS AND (OBSTACLE) DEPARTURE PROCEDURES

AMDT 1 07DEC17 (20366) (FAA)

TAKEOFF MINIMUMS:

Rwy 18, 300 - 1/4 or std. w/ min. climb of 285' per NM to 300.

TAKEOFF OBSTACLE NOTES:

Rwy 9, terrain, traverse way beginning 400' from DER, 150' right of centerline, up to 39' MSL.
Terrain, traverse way beginning 487' from DER, 113' right of centerline, up to 43' MSL.
Traverse way, terrain beginning 555' from DER, 18' left of centerline, up to 37' MSL.
Traverse way, terrain beginning 570' from DER, 199' right of centerline, up to 50' MSL.
Terrain beginning 586' from DER, 155' right of centerline, up to 55' MSL.
Traverse way, terrain beginning 600' from DER, 27' left of centerline, up to 49' MSL.
Terrain 745' from DER, 201' left of centerline, 50' MSL.
Traverse way 757' from DER, 199' left of centerline, 60' MSL.
Traverse way, terrain beginning 775' from DER, 75' left of centerline, up to 61' MSL.
Terrain, traverse way beginning 777' from DER, 3' right of centerline, up to 61' MSL.
Traverse way, terrain beginning 845' from DER, 29' right of centerline, up to 62' MSL.
Terrain beginning 969' from DER, 29' right of centerline, up to 67' MSL.
Terrain 1000' from DER, 505' left of centerline, 64' MSL.
Terrain beginning 1000' from DER, 280' left of centerline, up to 72' MSL.
Terrain beginning 1151' from DER, 194' left of centerline, up to 80' MSL.
Terrain, traverse way beginning 1183' from DER, 128' right of centerline, up to 106' MSL.
Terrain beginning 1396' from DER, 33' left of centerline, up to 83' MSL.
Terrain beginning 1400' from DER, 2' right of centerline, up to 120' MSL.
Terrain beginning 1539' from DER, 597' right of centerline, up to 124' MSL.
Terrain beginning 1554' from DER, 321' left of centerline, up to 89' MSL.
Tree, terrain beginning 1582' from DER, 0' of centerline, up to 9' AGL/131' MSL.
Terrain beginning 1638' from DER, 195' left of centerline, up to 90' MSL.
Terrain beginning 1800' from DER, 201' left of centerline, up to 100' MSL.
Tree, terrain beginning 1896' from DER, 39' right of centerline, up to 9' AGL/137' MSL.
Terrain beginning 1928' from DER, 9' left of centerline, up to 107' MSL.
Terrain 3548' from DER, 316' left of centerline, 109' MSL.
Terrain 3599' from DER, 820' left of centerline, 111' MSL.
Terrain 3599' from DER, 398' left of centerline, 114' MSL.
Terrain beginning 3600' from DER, 336' left of centerline, up to 117' MSL.
Terrain beginning 3636' from DER, 183' left of centerline, up to 120' MSL.
Terrain beginning 3799' from DER, 385' left of centerline, up to 124' MSL.
Tower 3948' from DER, 698' left of centerline, 27' AGL/147' MSL.
NAVAID, terrain beginning 3949' from DER, 519' left of centerline, up to 32' AGL/152' MSL.
Rwy 18, terrain, lighting beginning 3' from DER, 64' right of centerline, up to 15' MSL.
Lighting 9' from DER, 61' left of centerline, 2' AGL/12' MSL.
Traverse way, terrain, tree beginning 13' from DER, 143' right of centerline, up to 25' MSL.
Traverse way beginning 47' from DER, 196' left of centerline, up to 20' MSL.
Traverse way beginning 399' from DER, 179' right of centerline, up to 26' MSL.
Antenna 5815' from DER, 1697' left of centerline, 81' AGL/190' MSL.
Tower 5818' from DER, 1690' left of centerline, 107' AGL/218' MSL.
Rwy 27, traverse way beginning 5' from DER, 179' right of centerline, up to 25' MSL.
Traverse way beginning 36' from DER, 82' left of centerline, up to 25' MSL.
Rwy 36, lighting 8' from DER, 34' right of centerline, 1' AGL/13' MSL.
Lighting 9' from DER, 27' left of centerline, 1' AGL/13' MSL.
Pole, sign beginning 10' from DER, 66' left of centerline, up to 2' AGL/14' MSL.
Traverse way, vertical point beginning 12' from DER, 21' right of centerline, up to 20' MSL.
Traverse way beginning 172' from DER, 143' right of centerline, up to 21' MSL.
Vertical structure, traverse way beginning 312' from DER, 62' right of centerline, up to 31' AGL/40' MSL.
Tower, building, dome, antenna beginning 378' from DER, 394' left of centerline, up to 66' AGL/76' MSL.
NAVAID 1341' from DER, 612' right of centerline, 38' AGL/47' MSL.

25 JAN 2024 to 21 MAR 2024

25 JAN 2024 to 21 MAR 2024

TAKEOFF MINIMUMS, (OBSTACLE) DEPARTURE PROCEDURES, AND DIVERSE VECTOR AREA (RADAR VECTORS)

24025

AK

TAKEOFF MINIMUMS, (OBSTACLE) DEPARTURE PROCEDURES, AND DIVERSE VECTOR AREA (RADAR VECTORS)

24025

KOYUK, AK

KOYUK ALFRED ADAMS (KKA) (PAKU)

TAKEOFF MINIMUMS AND (OBSTACLE) DEPARTURE PROCEDURES

AMDT 1A 05NOV20 (20310) (FAA)

TAKEOFF MINIMUMS:

Rwy 1, NA - Obstacles.

DEPARTURE PROCEDURE:

Rwy 19, climb on heading 193° to 800 before proceeding on course.

TAKEOFF OBSTACLE NOTES:

Rwy 19, tree 11' from DER, 377' right of centerline, 23' AGL/197' MSL.

Trees, vegetation, pole, buildings, lighting beginning 47' from DER, 327' right of centerline, up to 34' AGL/211' MSL.

KOYUKUK, AK

KOYUKUK (KYU) (PFKU)

TAKEOFF MINIMUMS AND (OBSTACLE) DEPARTURE PROCEDURES

ORIG 22OCT09 (09295) (FAA)

DEPARTURE PROCEDURE:

Use DIBVY DEPARTURE.

KWETHLUK, AK

KWETHLUK (KWT) (PFKW)

TAKEOFF MINIMUMS AND (OBSTACLE) DEPARTURE PROCEDURES

ORIG 15JAN09 (09015) (FAA)

TAKEOFF MINIMUMS:

Rwy 18, 400-2 or std. w/ min. climb of 240' per NM to 500.

TAKEOFF OBSTACLE NOTES:

Rwy 18, trees beginning 292' from DER, 373' right of centerline, up to 35' AGL/63' MSL.

Trees beginning 341' from DER, 399' left of centerline, up to 35' AGL/134' MSL.

Rwy 36, trees beginning 95' from DER, 491' left of centerline, up to 35' AGL/84' MSL.

Trees beginning 203' from DER, 396' right of centerline, up to 18' AGL/42' MSL.

LADD AAF (FBK) (PAFB)

FAIRBANKS/FORT WAINWRIGHT, AK

TAKEOFF MINIMUMS AND (OBSTACLE) DEPARTURE PROCEDURES

AMDT 1C 19MAY22 (22139) (USA)

DEPARTURE PROCEDURE:

Rwy 7, climbing right turn via hdg 180° and FAI VORTAC R-090 to 5000 direct FAI (hold south, right turn, 348° inbound) continue climb in hold to 5000, before proceeding on course.**Rwy 25**, climbing left turn via hdg 180° and FAI VORTAC R-090 to 5000 direct FAI (hold south, right turn, 348° inbound) continue climb in hold to 5000, before proceeding on course.

TAKEOFF OBSTACLE NOTES:

Rwy 7, public road 387' east of DER, up to 15' AGL/460' MSL.**Rwy 25**, public road 349' west of DER, up to 15' AGL/460' MSL.

Railroad tracks 556' west of DER, up to 23' AGL/461' MSL.

Trees 556' west of DER, up to 25' AGL/460' MSL.

MANLEY HOT SPRINGS, AK

MANLEY HOT SPRINGS (MLY) (PAML)

TAKEOFF MINIMUMS AND (OBSTACLE) DEPARTURE PROCEDURES

ORIG 19JUL18 (18200) (FAA)

TAKEOFF MINIMUMS:

Rwy 36, NA-Obstacles

DEPARTURE PROCEDURE:

Rwy 18, climb on a heading between 050° CW 220° from DER.

TAKEOFF OBSTACLE NOTES:

Rwy 18, trees beginning 286' from DER, 562' right of centerline, up to 68' AGL/334' MSL.

Tree 356' from DER, 592' left of centerline, 67' AGL/334' MSL.

Trees beginning 439' from DER, 586' left of centerline, up to 74' AGL/342' MSL.

Trees beginning 678' from DER, 585' right of centerline, up to 70' AGL/336' MSL.

Trees beginning 1087' from DER, 64' left of centerline, up to 86' AGL/355' MSL.

Tree 1923' from DER, 597' right of centerline, 70' AGL/337' MSL.

Trees beginning 1933' from DER, 129' right of centerline, up to 77' AGL/346' MSL.

Trees beginning 2435' from DER, 743' left of centerline, up to 92' AGL/360' MSL.

Trees beginning 2583' from DER, 553' left of centerline, up to 93' AGL/361' MSL.

Trees beginning 2621' from DER, 21' left of centerline, up to 93' AGL/362' MSL.

Tree 2666' from DER, 1053' right of centerline, 80' AGL/348' MSL.

Trees beginning 2860' from DER, 117' right of centerline, up to 85' AGL/353' MSL.

Trees beginning 2901' from DER, 278' left of centerline, up to 96' AGL/365' MSL.

Tree 2989' from DER, 731' left of centerline, 99' AGL/366' MSL.

Trees beginning 2992' from DER, 328' left of centerline, up to 98' AGL/367' MSL.

Tree 3008' from DER, 38' right of centerline, 88' AGL/356' MSL.

Trees beginning 3328' from DER, 7' left of centerline, up to 100' AGL/368' MSL.

CON'T

TAKEOFF MINIMUMS, (OBSTACLE) DEPARTURE PROCEDURES, AND DIVERSE VECTOR AREA (RADAR VECTORS)

24025

TAKEOFF MINIMUMS, (OBSTACLE) DEPARTURE PROCEDURES, AND DIVERSE VECTOR AREA (RADAR VECTORS)

24025

MANLEY HOT SPRINGS, AK (CON'T)

MANLEY HOT SPRINGS (MLY) (PAML) (CON'T)

Rwy 18 (CON'T), tree 3383' from DER, 15' right of centerline, 95' AGL/363' MSL.
Tree 3523' from DER, 376' right of centerline, 97' AGL/365' MSL.
Tree 3571' from DER, 232' left of centerline, 103' AGL/371' MSL.
Tree 3573' from DER, 497' right of centerline, 97' AGL/366' MSL.
Tree 3836' from DER, 41' right of centerline, 105' AGL/373' MSL.

MANOKOTAK, AK

MANOKOTAK (MBA) (PAMB)

TAKEOFF MINIMUMS AND (OBSTACLE) DEPARTURE PROCEDURES

AMDT 1 27AUG09 (09239) (FAA)

DEPARTURE PROCEDURE:

Rwy 3, climbing right turn to 2000 direct DLG VOR/DME, continue climb in DLG VOR/DME holding pattern (hold South, right turn, 011° inbound) to cross DLG VOR/DME at or above MEA for route of flight.

Rwy 21, climbing left turn to 2000 direct DLG VOR/DME, continue climb in DLG VOR/DME holding pattern (hold South, right turn, 011° inbound) to cross DLG VOR/DME at or above MEA for route of flight.

TAKEOFF OBSTACLE NOTES:

Rwy 3, trees beginning 1519' from DER, 899' right of centerline, up to 35' AGL/134' MSL.

Trees beginning 595' from DER, 150' left of centerline, up to 35' AGL/134' MSL.

Rising terrain 42' from DER, 136' right of centerline up to 105' MSL.

Rising terrain 12' from DER, 301' left of centerline up to 102' MSL.

Rwy 21, multiple trees beginning 136' from DER, 133' right of centerline, up to 35' AGL/109' MSL.

Multiple buildings beginning 359' from DER, 343' left of centerline, up to 30' AGL/96' MSL.

MARSHALL, AK

MARSHALL DON HUNTER SR (MDM) (PADM)

TAKEOFF MINIMUMS AND (OBSTACLE) DEPARTURE PROCEDURES

AMDT 1 29JUL10 (10210) (FAA)

DEPARTURE PROCEDURE:

use BIBNE RNAV DEPARTURE.

MC GRATH, AK

MC GRATH (MCG) (PAMC)

TAKEOFF MINIMUMS AND (OBSTACLE) DEPARTURE PROCEDURES

AMDT 2C 14JUL22 (22195) (FAA)

TAKEOFF MINIMUMS:

Rwys 5, 23, NA-Environmental.

Rwy 16, std. w/min. climb of 470' per NM to 1700, or 2300-3 for VCOA.

Rwy 34, std. w/min. climb of 420' per NM to 2200, or 2300-3 for VCOA.

DEPARTURE PROCEDURE:

Rwy 16, climb on heading 160° to 1700, then climbing left turn on heading 014° thence...

Rwy 34, climb on heading 340° to 2200, then climbing right turn heading 166° to MCG R-104 or direct VTR NDB thence...

...climb to 4000 southeast bound on MCG R-104, or 100° bearing from VTR NDB. Aircraft southeast bound (079° clockwise 119°) continue climb on course to MEA for route of flight. All others reverse course on the MCG R-104 to MCG VORTAC, or 280° course to VTR NDB, then continue climb on course to MEA for route of flight.

VCOA:

Rwys 16, 34, obtain ATC approval for VCOA when requesting IFR clearance. Climb in visual conditions to cross Mc Grath airport at or above 2200 before proceeding on course.

TAKEOFF OBSTACLE NOTES:

Rwy 16, vehicle on road beginning 8' from DER, 66' right of centerline, up to 351' MSL.

Vehicle on road beginning 141' from DER, 70' left of centerline, up to 349' MSL.

Vehicle on road beginning 178' from DER, 344' left of centerline, up to 350' MSL.

Trees beginning 930' from DER, 284' right of centerline, up to 399' MSL.

Trees beginning 1020' from DER, 116' right of centerline, up to 407' MSL.

Trees beginning 1159' from DER, 50' right of centerline, up to 409' MSL.

Trees beginning 1190' from DER, 306' left of centerline, up to 392' MSL.

Trees beginning 1235' from DER, 14' left of centerline, up to 406' MSL.

Trees beginning 1262' from DER, 18' right of centerline, up to 422' MSL.

Trees beginning 1551' from DER, 19' left of centerline, up to 408' MSL.

Trees beginning 1880' from DER, 16' left of centerline, up to 412' MSL.

Trees beginning 2529' from DER, 317' right of centerline, up to 429' MSL.

Tree 2552' from DER, 315' left of centerline, 413' MSL.

Tree 2575' from DER, 534' left of centerline, 416' MSL.

Trees beginning 2642' from DER, 270' left of centerline, up to 418' MSL.

Tree 2880' from DER, 596' left of centerline, 420' MSL.

Tree 3116' from DER, 93' left of centerline, 421' MSL.

Tree 3219' from DER, 748' left of centerline, 425' MSL.

Tree 3253' from DER, 46' left of centerline, 90' AGL/428' MSL.

Rwy 34, lighting 10' from DER, 59' right of centerline, 2' AGL/344' MSL.

Vegetation, trees beginning 12' from DER, 28' left of centerline, up to 351' MSL.

Vegetation 53' from DER, 237' right of centerline, 350' MSL.

Trees beginning 76' from DER, 78' right of centerline, up to 351' MSL.

CON'T

TAKEOFF MINIMUMS, (OBSTACLE) DEPARTURE PROCEDURES, AND DIVERSE VECTOR AREA (RADAR VECTORS)

24025

TAKEOFF MINIMUMS, (OBSTACLE) DEPARTURE PROCEDURES, AND DIVERSE VECTOR AREA (RADAR VECTORS)

24025

MC GRATH, AK (CON'T)

MC GRATH (MCG) (PAMC) (CON'T)

Rwy 34 (CON'T), trees beginning 172' from DER, 142' right of centerline, up to 17' AGL/354' MSL.

Trees beginning 1420' from DER, 440' left of centerline, up to 388' MSL.

Trees beginning 1557' from DER, 320' left of centerline, up to 389' MSL.

Trees beginning 1705' from DER, 282' left of centerline, up to 408' MSL.

Tree 1757' from DER, 878' right of centerline, 392' MSL.

Trees beginning 1888' from DER, 807' right of centerline, up to 411' MSL.

Trees beginning 1942' from DER, 667' left of centerline, up to 414' MSL.

Trees beginning 2065' from DER, 671' right of centerline, up to 421' MSL.

Tree 2235' from DER, 1014' left of centerline, 416' MSL.

Tree 2759' from DER, 250' left of centerline, 417' MSL.

Tree 3106' from DER, 1063' left of centerline, 422' MSL.

Tree 3341' from DER, 1099' left of centerline, 428' MSL.

MEKORYUK, AK

MEKORYUK (MYU) (PAMY)

TAKEOFF MINIMUMS AND (OBSTACLE) DEPARTURE PROCEDURES

AMDT 2 12AUG21 (21224) (FAA)

DEPARTURE PROCEDURE:

Rwy 24, climb on heading 245° to 900 before turning left.

TAKEOFF OBSTACLE NOTES:

Rwy 6, vegetation beginning 6' from DER, 175' right of centerline, up to 5' AGL/58' MSL.

Vegetation 68' from DER, 270' left of centerline, 2' AGL/55' MSL.

Vehicles on road and vegetation beginning 74' from DER, 186' left of centerline, up to 69' MSL.

Antenna and vehicles on road beginning 98' from DER, 384' left of centerline, up to 21' AGL/71' MSL.

Wind indicator and vehicles on road beginning 250' from DER, 300' left of centerline, up to 25' AGL/74' MSL.

Building and vehicles on road beginning 439' from DER, 370' left of centerline, up to 27' AGL/80' MSL.

Pole and vehicles on road beginning 517' from DER, 341' left of centerline, up to 34' AGL/85' MSL.

Poles beginning 731' from DER, 616' left of centerline, up to 37' AGL/92' MSL.

Rwy 24, vegetation 3' from DER, 396' right of centerline, 2' AGL/61' MSL.

Vegetation beginning 5' from DER, 227' left of centerline, up to 2' AGL/55' MSL.

Vegetation beginning 55' from DER, 385' right of centerline, up to 2' AGL/62' MSL.

Vegetation beginning 98' from DER, 273' left of centerline, up to 2' AGL/56' MSL.

MIDDLETON ISLAND, AK

MIDDLETON ISLAND (MDO) (PAMD)

TAKEOFF MINIMUMS AND (OBSTACLE) DEPARTURE PROCEDURES

ORIG-A 10JAN13 (13010) (FAA)

TAKEOFF MINIMUMS:

Rwys 13, 31, NA-Environmental.

TAKEOFF OBSTACLE NOTES:

Rwy 2, aircraft on taxiway, 5' from DER, 195' left of centerline, up to 20' AGL/119' MSL.

Vehicle on taxiway, 131' from DER, 193' left of centerline, up to 15' AGL/114' MSL.

Rwy 20, vehicles on road beginning 3' from DER, 124' right of centerline, up to 15' AGL/164' MSL.

MINCHUMINA, AK

MINCHUMINA (MHM) (PAMH)

TAKEOFF MINIMUMS AND (OBSTACLE) DEPARTURE PROCEDURES

AMDT 2A 31MAR16 (16091) (FAA)

TAKEOFF MINIMUMS:

Rwy 3, 1600-3 for climb in visual conditions. Procedure NA at night

DEPARTURE PROCEDURE:

Rwy 3, for climb in visual conditions: Cross MHM NDB north bound at or above 1600 MSL before proceeding on course.

Rwy 21, climb via heading 204° to 1600 before proceeding on course.

TAKEOFF OBSTACLE NOTES:

Rwy 3, light 10' from DER, 30' right of centerline, 2' AGL/681' MSL.

Trees and bush, beginning 27' from DER, 99' left of centerline, up to 689' MSL.

Tree, 122' from DER, 339' left of centerline, 736' MSL.

Trees, beginning 123' from DER, 184' right of centerline, up to 685' MSL.

Trees and terrain beginning 144' from DER, 209' left of centerline, up to 764' MSL.

Rwy 21, tree and light beginning 3' from DER, 30' left of centerline, up to 713' MSL.

Light, trees and bush beginning 10' from DER, 50' right of centerline, up to 716' MSL.

Pole 108' from DER, 298' left of centerline, 679' MSL.

Trees beginning 342' from DER, 440' right of centerline, up to 719' MSL.

Trees beginning 399' from DER, 300' right of centerline, up to 742' MSL.

25 JAN 2024 to 21 MAR 2024

25 JAN 2024 to 21 MAR 2024

TAKEOFF MINIMUMS, (OBSTACLE) DEPARTURE PROCEDURES, AND DIVERSE VECTOR AREA (RADAR VECTORS)

24025

AK

TAKEOFF MINIMUMS, (OBSTACLE) DEPARTURE PROCEDURES, AND DIVERSE VECTOR AREA (RADAR VECTORS)

24025

MOUNTAIN VILLAGE, AK

MOUNTAIN VILLAGE (MOU) (PAMO)

TAKEOFF MINIMUMS AND (OBSTACLE) DEPARTURE PROCEDURES

AMDT 2 30JAN20 (20030) (FAA)

TAKEOFF OBSTACLE NOTES:

Rwy 2, lighting 9' from DER, 47' right of centerline, 341' MSL.

Lighting 9' from DER, 47' left of centerline, 340' MSL.

Rwy 20, lighting 9' from DER, 47' left of centerline, 299' MSL.

Lighting 10' from DER, 47' right of centerline, 299' MSL.

NAPAKIAK, AK

NAPAKIAK (WNA) (PANA)

TAKEOFF MINIMUMS AND (OBSTACLE) DEPARTURE PROCEDURES

ORIG 17OCT13 (13290) (FAA)

TAKEOFF OBSTACLE NOTES:

Rwy 16, numerous trees beginning 47' from DER, 161' right of centerline, up to 13' AGL/30' MSL.

Tree 465' from DER, 22' left of centerline, 16' AGL/33' MSL.

Rwy 34, numerous poles beginning 299' from DER, 287' left of centerline, up to 29' AGL/46' MSL.

Numerous poles beginning 177' right of centerline, 273' right of centerline, up to 26' AGL/43' MSL.

Rod on tower 359' from DER, 430' left of centerline, 30' AGL/47' MSL.

Antenna 357' from DER, 408' right of centerline, 29' AGL/46' MSL.

Catenary 215' from DER, 352' right of centerline, 19' AGL/36' MSL.

Tree 206' from DER, 297' left of centerline, 15' AGL/32' MSL.

Multiple buildings beginning 639' from DER, 414' left of centerline, up to 26' AGL/43' MSL.

Tree 520' from DER, 437' right of centerline, 13' AGL/30' MSL.

NAPASKIAK, AK

NAPASKIAK (PKA) (PAPK)

TAKEOFF MINIMUMS AND (OBSTACLE) DEPARTURE PROCEDURES

ORIG 05MAR15 (15064) (FAA)

TAKEOFF OBSTACLE NOTES:

Rwy 2, boats 25' from DER, 468' left of centerline, up to 50' AGL/50' MSL.

Trees 33' from DER, 141' left of centerline, up to 50' AGL/74' MSL.

Trees beginning 527' from DER, left and right of centerline, up to 50' AGL/74' MSL.

Trees 917' from DER, beginning 29' left of centerline, up to 50' AGL/74' MSL.

Rwy 20, trees beginning 32' from DER, left and right of centerline, up to 50' AGL/74' MSL.

Boats 620' from DER, 618' right of centerline, up to 50' AGL/50' MSL.

Trees beginning 1100' from DER, left and right of centerline, up to 50' AGL/74' MSL.

NELSON LAGOON, AK

NELSON LAGOON (OUL) (PAOU)

TAKEOFF MINIMUMS AND (OBSTACLE) DEPARTURE PROCEDURES

AMDT 1 05DEC19 (19339) (FAA)

DEPARTURE PROCEDURE:

Use BINAL TWO DEPARTURE.

TAKEOFF OBSTACLE NOTES:

Rwy 8, trees beginning 77' from DER, 210' left of centerline, up to 20' AGL/43' MSL.

Trees beginning 142' from DER, 56' right of centerline, up to 20' AGL/30' MSL.

Rwy 26, trees beginning 21' from DER, 10' right of centerline, up to 20' AGL/40' MSL.

Trees 265' from DER, 559' left of centerline, 20' AGL/34' MSL.

Trees beginning 296' from DER, 25' left of centerline, up to 20' AGL/40' MSL.

NENANA, AK

NENANA MUNI (ENN) (PANN)

TAKEOFF MINIMUMS AND (OBSTACLE) DEPARTURE PROCEDURES

AMDT 4 22OCT09 (09295) (FAA)

TAKEOFF MINIMUMS:

Rwy 4L, 600-2½ or std. with a min. climb of 325' per NM to 1100.**Rwys 4R, 4W, 22L, 22W**, NA-ATC.

DEPARTURE PROCEDURE:

Rwy 4L, climbing right turn via heading 127° to 1900 then climbing right turn direct ENN VORTAC, thence...**Rwy 22R**, climb via heading 218° to 1800 then climbing left turn direct ENN VORTAC, thence...

...continue climb in ENN VORTAC holding pattern (Southwest, left turn, 042° inbound) to MEA for route of flight before proceeding on course.

TAKEOFF OBSTACLE NOTES:

Rwy 4L, trees beginning 1.9 NM from DER, 3209' left of centerline, up to 60' AGL/859' MSL.

TAKEOFF MINIMUMS, (OBSTACLE) DEPARTURE PROCEDURES, AND DIVERSE VECTOR AREA (RADAR VECTORS)

24025

TAKEOFF MINIMUMS, (OBSTACLE) DEPARTURE PROCEDURES, AND DIVERSE VECTOR AREA (RADAR VECTORS)

24025

NEW STUYAHOK, AK

NEW STUYAHOK (KNW) (PANW)

TAKEOFF MINIMUMS AND (OBSTACLE) DEPARTURE PROCEDURES

AMDT 1A 05JAN17 (17005) (FAA)

TAKEOFF OBSTACLE NOTES:

- Rwy 14**, lt pole 9' from DER, 47' right of centerline, 5' AGL/329' MSL.
- Trees beginning 388' from DER, 299' right of centerline, up to 25' AGL/343' MSL.
- Rwy 14**, REIL 41' from DER, 84' right of centerline, 372' MSL.
- Tank 177' from DER, 423' right of centerline, 11' AGL/381' MSL.
- Tree 204' from DER, 467' left of centerline, 376' MSL.
- Tree 293' from DER, 533' left of centerline, 383' MSL.
- Trees beginning 478' from DER, 494' left of centerline, up to 390' MSL.
- Trees beginning 558' from DER, 350' right of centerline, up to 389' MSL.

NIKOLAI, AK

NIKOLAI (FSP) (PAFS)

TAKEOFF MINIMUMS AND (OBSTACLE) DEPARTURE PROCEDURES

AMDT 1 19JUL18 (18200) (FAA)

TAKEOFF OBSTACLE NOTES:

- Rwy 5**, lighting 0' from DER, 80' right of centerline, 5' AGL/451' MSL.
- Trees beginning 80' from DER, 317' left of centerline, up to 20' AGL/476' MSL.
- Vegetation 102' from DER, 89' right of centerline, 452' MSL.
- Trees beginning 103' from DER, 498' right of centerline, up to 472' MSL.
- Tree, vehicles on road beginning 146' from DER, 76' left of centerline, up to 506' MSL.
- Tree 284' from DER, 498' left of centerline, 67' AGL/535' MSL.
- Tree, building beginning 303' from DER, 144' left of centerline, up to 77' AGL/547' MSL.
- Trees beginning 432' from DER, 265' right of centerline, up to 480' MSL.
- Tree 650' from DER, 639' right of centerline, 488' MSL.
- Trees beginning 716' from DER, 421' right of centerline, up to 496' MSL.
- Tree 937' from DER, 675' right of centerline, 497' MSL.
- Trees beginning 972' from DER, 7' right of centerline, up to 74' AGL/528' MSL.
- Rwy 23**, vegetation 0' from DER, 134' left of centerline, 446' MSL.
- Trees beginning 6' from DER, 124' right of centerline, up to 458' MSL.
- Trees beginning 48' from DER, 143' right of centerline, up to 484' MSL.
- Vegetation 89' from DER, 272' left of centerline, 448' MSL.
- Vegetation 100' from DER, 93' left of centerline, 449' MSL.
- Vehicle on road 444' from DER, 550' left of centerline, 457' MSL.
- Tree 648' from DER, 506' left of centerline, 473' MSL.
- Trees beginning 662' from DER, 310' left of centerline, up to 484' MSL.
- Trees beginning 698' from DER, 261' right of centerline, up to 494' MSL.
- Trees beginning 880' from DER, 104' left of centerline, up to 487' MSL.
- Trees beginning 1362' from DER, 67' left of centerline, up to 496' MSL.
- Tree 1547' from DER, 633' left of centerline, 498' MSL.
- Tree 1638' from DER, 890' right of centerline, 501' MSL.
- Tree 1747' from DER, 892' right of centerline, 503' MSL.

NOATAK, AK

NOATAK (WTK) (PAWN)

TAKEOFF MINIMUMS AND (OBSTACLE) DEPARTURE PROCEDURES

AMDT 2 08NOV18 (18312) (FAA)

DEPARTURE PROCEDURE:

- Rwy 1**, climb heading 011° to 1900' before proceeding on course.

TAKEOFF OBSTACLE NOTES:

- Rwy 1**, traverse way 52' from DER, 460' right of centerline, 15' AGL/97' MSL.
- Building 100' from DER, 271' left of centerline, 26' AGL/115' MSL.
- Lighting, traverse way, pole beginning 105' from DER, 320' left of centerline, up to 26' AGL/118' MSL.
- Pole, traverse way, wind indicator beginning 129' from DER, 311' right of centerline, up to 36' AGL/118' MSL.
- Antenna 1306' from DER, 224' left of centerline, 44' AGL/129' MSL.
- Building 1446' from DER, 375' right of centerline, 40' AGL/128' MSL.
- Tower, antenna beginning 1959' from DER, 249' left of centerline, up to 100' AGL/187' MSL.
- Rwy 19**, trees beginning 144' from DER, 240' left of centerline, up to 101' MSL.
- Tree 167' from DER, 353' right of centerline, 92' MSL.
- Trees beginning 283' from DER, 245' left of centerline, up to 102' MSL.
- Tree 746' from DER, 649' left of centerline, 104' MSL.

TAKEOFF MINIMUMS, (OBSTACLE) DEPARTURE PROCEDURES, AND DIVERSE VECTOR AREA (RADAR VECTORS)

24025

TAKEOFF MINIMUMS, (OBSTACLE) DEPARTURE PROCEDURES, AND DIVERSE VECTOR AREA (RADAR VECTORS)

24025

NOME, AK

NOME (OME) (PAOM)

TAKEOFF MINIMUMS AND (OBSTACLE) DEPARTURE PROCEDURES

AMDT 6 13NOV14 (14317) (FAA)

TAKEOFF MINIMUMS:

Rwy 3, std. w/min. climb of 480' per NM to 1800, or 1600-2½ for VCOA.

DEPARTURE PROCEDURE:

Rwy 3, climbing right turn to OME VOR/DME, thence ...

Rwy 10, climb on heading 099° to 1200 thence ...

Rwys 21, 28, turn left direct OME VOR/DME/FDV NDB, thence ...

... Departures northeast CW through westbound (040° CW 260°), climb on course. Departures west CW through northeast bound (260° CW 040°), climb southeast bound on OME VOR/DME R-144 or 148° bearing from FDV NDB to 2200, then turn right via direct OME VOR/DME/FDV NDB. Continue climb on course.

VCOA:

Rwy 3, obtain ATC approval for VCOA when requesting IFR clearance. Climb in visual conditions to cross Nome Airport at or above 1500 before proceeding on course.

TAKEOFF OBSTACLE NOTES:

Rwy 3, pole 1058' from DER, 236' right of centerline, 37' AGL/88' MSL.

Secondary road beginning 27' from DER, 19' right of centerline up to 15' AGL/69' MSL.

Trees beginning 249' from DER, 2' right of centerline, up to 15' AGL/61' MSL.

Poles beginning 1519' from DER, 310' left of centerline, up to 43' AGL/101' MSL.

Secondary road beginning 23' from DER, 17' left of centerline, up to 15' AGL/78' MSL.

Bushes beginning 17' from DER, 118' left of centerline, up to 2' AGL/50' MSL.

Trees beginning 339' from DER, 6' left of centerline, up to 10' AGL/62' MSL.

Rwy 10, chimney/stacks beginning 752' from DER, 503' right of centerline, up to 64' AGL/76' MSL.

Pole 748' from DER, 608' right of centerline, 38' AGL/59' MSL.

Pole 423' from DER, 471' right of centerline, 20' AGL/48' MSL.

Pole 777' from DER, 610' right of centerline, 35' AGL/56' MSL.

Antenna on pole 674' from DER, 521' right of centerline, 39' AGL/52' MSL.

Pole 792' from DER, 502' right of centerline, 40' AGL/53' MSL.

Pole 867' from DER, 666' right of centerline, 43' AGL/55' MSL.

Antenna on pole 676' from DER, 572' right of centerline, 34' AGL/46' MSL.

Pole 956' from DER, 735' right of centerline, 39' AGL/51' MSL.

Pole 784' from DER, 603' right of centerline, 30' AGL/43' MSL.

Building 764' from DER, 589' right of centerline, 28' AGL/54' MSL.

Road beginning 199' from DER, 493' right of centerline, 15' AGL/30' MSL.

Tower 3753' from DER 1355' right of centerline, 90' AGL/120' MSL.

Pole 1707' from DER, 923' left of centerline, 41' AGL/93' MSL.

Pole 1874' from DER, 611' left of centerline, 36' AGL/86' MSL.

Pole 1731' from DER, 594' left of centerline, 24' AGL/71' MSL.

Building 1051' from DER, 742' left of centerline, 18' AGL/63' MSL.

Rwy 21, trees beginning 377' from DER, 48' right of centerline, up to 11' AGL/46' MSL.

Bushes beginning 187' from DER, 174' right of centerline, up to 3' AGL/45' MSL.

Secondary road beginning 559' from DER, 140' right of centerline, up to 15' AGL/47' MSL.

Ground 188' from DER, 396' right of centerline, 19' MSL.

Bushes beginning 595' from DER, 152' left of centerline, 13' AGL/48' MSL.

Trees beginning 585' from DER, 2' left of centerline, up to 9' AGL/40' MSL.

Secondary road beginning 540' from DER, 47' left of centerline, up to 15' AGL/43' MSL.

Poles beginning 1547' from DER, 89' left of centerline, up to 32' AGL/62' MSL.

Ground 597' from DER, 397' left of centerline, 29' MSL.

Rwy 28, obstruction light on localizer 1303' from DER, 42' right of centerline, 15' AGL/51' MSL.

Navaid 15' from DER, 152' right of centerline, 4' AGL/17' MSL.

Pole 122' from DER, 521' left of centerline, 45' AGL/72' MSL.

Pole 121' from DER, 399' left of centerline, 15' AGL/42' MSL.

Debris 415' from DER, 377' left of centerline, up to 9' AGL/50' MSL.

Secondary road beginning 181' from DER, 259' left of centerline, up to 15' AGL/48' MSL.

Ground beginning 168' from DER, 262' left of centerline, up to 63' MSL.

Buildings beginning 398' from DER, 203' left of centerline, up to 32' AGL/57' MSL.

Trees beginning 90' from DER, 361' left of centerline, up to 10' AGL/21' MSL.

Trees beginning 919' from DER, 357' left of centerline, 9' AGL/62' MSL.

Fence beginning 396' from DER, 245' left of centerline, up to 7' AGL/30' MSL.

Antenna on DME LTD 1314' from DER, 213' left of centerline, 28' AGL/63' MSL.

Sign 390' from DER, 246' left of centerline, 2' AGL/29' MSL.

NAVAID 15' from DER, 152' left of centerline, 4' AGL/17' MSL.

NONDALTON, AK

NONDALTON (5NN) (PANO)

TAKEOFF MINIMUMS AND (OBSTACLE) DEPARTURE PROCEDURES

ORIG 16FEB06 (06047) (FAA)

TAKEOFF MINIMUMS:

Rwy 2, NA-obstacles.

DEPARTURE PROCEDURE:

Rwy 20, Use ILIAMNA DEPARTURE.

TAKEOFF MINIMUMS, (OBSTACLE) DEPARTURE PROCEDURES, AND DIVERSE VECTOR AREA (RADAR VECTORS)

24025

AK

TAKEOFF MINIMUMS, (OBSTACLE) DEPARTURE PROCEDURES, AND DIVERSE VECTOR AREA (RADAR VECTORS)

24025

NOORVIK, AK

ROBERT/BOB/CURTIS MEML (D76) (PFNO)

TAKEOFF MINIMUMS AND (OBSTACLE) DEPARTURE PROCEDURES

AMDT 1 31DEC20 (20366) (FAA)

DEPARTURE PROCEDURE:

Rwy 6, climbing left turn to a heading between 244° CW to 286° from DER to 3800 before proceeding on course, or min. climb of 320' per NM to 2500 for a heading between 287° CW to 243°.

Rwy 24, climb on a heading between 110° CW to 314° from DER to 3700 before proceeding on course, or min. climb of 240' per NM to 2300 for a heading between 315° CW to 063°, and min. climb of 240' per NM to 2300 for a heading between 064° CW to 109°.

NORTHWAY, AK

NORTHWAY (ORT) (PAOR)

TAKEOFF MINIMUMS AND (OBSTACLE) DEPARTURE PROCEDURES

AMDT 2 18JAN17 (07018) (FAA)

DEPARTURE PROCEDURE:

Rwy 5, climbing right turn to 4000 via ORT R-100, then climbing right turn to 8000 direct ORT VORTAC, continue climb in ORT VORTAC holding pattern (West, right turn, 108° inbound) to 8000 before proceeding on course. . . .

Rwy 23, climbing left turn to 4000 via ORT R-170, then climbing left turn to 8000 direct ORT VORTAC, continue climb in ORT VORTAC holding pattern (West, right turn, 108° inbound) to 8000 before proceeding on course. . . .

. . . continue climb via assigned route.

TAKEOFF OBSTACLE NOTES:

Rwy 5, multiple trees beginning 1133' from DER, 727' right of centerline, up to 60' AGL/1859' MSL.

Multiple trees beginning 3881' from DER, 1522' left of centerline, up to 60' AGL/1859' MSL.

Rwy 23, multiple trees beginning 777' from DER, 560' left of centerline, up to 60' AGL/1809' MSL.

Multiple trees beginning 1365' from DER, 527' right of centerline, up to 60' AGL/1809' MSL.

NUIQSUT, AK

NUIQSUT (AQT) (PAQT)

TAKEOFF MINIMUMS AND (OBSTACLE) DEPARTURE PROCEDURES

ORIG 08APR10 (10098) (FAA)

TAKEOFF OBSTACLE NOTES:

Rwy 5, road with vehicles beginning 165' from DER, left and right of centerline, up to 15' AGL/89' MSL.

Rwy 23, terrain beginning 211' from DER, 523' left of centerline to 450' right of centerline, up to 74' MSL.

NULATO, AK

NULATO (NUL) (PANU)

TAKEOFF MINIMUMS AND (OBSTACLE) DEPARTURE PROCEDURES

AMDT 1 05JAN17 (17005) (FAA)

TAKEOFF MINIMUMS:

Rwy 3, 600-2½ w/min. climb of 245' per NM to 1200 or 1200-2½ for VCOA.

DEPARTURE PROCEDURE:

Rwy 3, climb heading 029° to 1600 before turning left.

Rwy 21, climb heading 209° to 1500 before proceeding on course.

VCOA: Obtain ATC approval for VCOA when requesting IFR clearance. Climb in visual conditions to cross Nulato airport at or above 1500 before proceeding on course.

TAKEOFF OBSTACLE NOTES:

Rwy 3, trees beginning 16' from DER, 237' right of centerline, up to 60' AGL/459' MSL.

Trees beginning 18' from DER, 379' left of centerline, up to 60' AGL/459' MSL.

Trees beginning 738' from DER, 54' right of centerline, up to 60' AGL/559' MSL.

Trees beginning 1673' from DER, 179' right of centerline, up to 60' AGL/559' MSL.

Trees beginning 2402' from DER, 93' right of centerline, up to 60' AGL/615' MSL.

Trees beginning 4969' from DER, 293' right of centerline, up to 60' AGL/659' MSL.

Trees beginning 6071' from DER, 263' right of centerline, up to 60' AGL/759' MSL.

Trees beginning 1.2 NM from DER, 637' left of centerline, up to 60' AGL/859' MSL.

Trees beginning 1.4 NM from DER, 1026' left of centerline, up to 60' AGL/959' MSL.

Trees beginning 2 NM from DER, 785' left of centerline, up to 60' AGL/959' MSL.

Tree 2.2 NM from DER, 4145' left of centerline, 60' AGL/859' MSL.

Rwy 21, trees, beginning 15' from DER, 118' right of centerline, up to 60' AGL/459' MSL.

25 JAN 2024 to 21 MAR 2024

25 JAN 2024 to 21 MAR 2024

TAKEOFF MINIMUMS, (OBSTACLE) DEPARTURE PROCEDURES, AND DIVERSE VECTOR AREA (RADAR VECTORS)

24025

AK

TAKEOFF MINIMUMS, (OBSTACLE) DEPARTURE PROCEDURES, AND DIVERSE VECTOR AREA (RADAR VECTORS)

24025

PALMER, AK

WARREN "BUD" WOODS PALMER MUNI (PAQ) (PAAQ)

TAKEOFF MINIMUMS AND (OBSTACLE) DEPARTURE PROCEDURES

AMDT 2B 08NOV18 (18312) (FAA)

TAKEOFF MINIMUMS:

Rwy 10, NA-Obstacles.

DEPARTURE PROCEDURE:

Rwys 16, 28, 34, Use PALMER RNAV DEPARTURE.

TAKEOFF OBSTACLE NOTES:

Rwy 16, NAVAID beginning 3' from DER, 40' right of centerline, up to 2' AGL/222' MSL.

NAVAID, fence beginning 4' from DER, 49' left of centerline, up to 1' AGL/222' MSL.

Terrain beginning 197' from DER, 393' right of centerline, up to 227' MSL.

Trees beginning 584' from DER, 161' left of centerline, up to 60' AGL/274' MSL.

Catenary 910' from DER, 623' right of centerline, 39' AGL/259' MSL.

Trees beginning 991' from DER, 40' right of centerline, up to 72' AGL/292' MSL.

Trees beginning 2340' from DER, 246' right of centerline, up to 90' AGL/301' MSL.

Rwy 28, NAVAID beginning 3' from DER, 27' right of centerline, up to 2' AGL/234' MSL.

NAVAID beginning 11' from DER, 37' left of centerline, up to 1' AGL/234' MSL.

Vegetation 11' from DER, 48' right of centerline, 3' AGL/236' MSL.

Vertical structure, tree, vegetation beginning 20' from DER, 183' right of centerline, up to 22' AGL/259' MSL.

Trees beginning 20' from DER, 10' left of centerline, up to 90' AGL/322' MSL.

Tree, vegetation beginning 278' from DER, 18' right of centerline, up to 79' AGL/317' MSL.

Tree, pole, catenary, antenna beginning 513' from DER, 12' right of centerline, up to 92' AGL/328' MSL.

Trees beginning 1377' from DER, 45' left of centerline, up to 94' AGL/331' MSL.

Beginning 2121' from DER, 594' left of centerline, up to 97' AGL/337' MSL.

Trees beginning 3799' from DER, 876' left of centerline, up to 67' AGL/345' MSL.

Tree 3965' from DER, 773' left of centerline, 69' AGL/354' MSL.

Rwy 34, tree, NAVAID beginning 1' from DER, 39' right of centerline, up to 79' AGL/287' MSL.

NAVAID beginning 9' from DER, 40' left of centerline, up to 2' AGL/250' MSL.

Sign 28' from DER, 198' left of centerline, 3' AGL/251' MSL.

Vegetation 38' from DER, 431' left of centerline, 4' AGL/253' MSL.

Tree 73' from DER, 192' right of centerline, 47' AGL/289' MSL.

Trees beginning 138' from DER, 144' right of centerline, up to 82' AGL/306' MSL.

Vegetation beginning 164' from DER, 287' left of centerline, up to 2' AGL/255' MSL.

Tree 270' from DER, 545' left of centerline, 5' AGL/257' MSL.

Tree, catenary, pole beginning 393' from DER, 108' right of centerline, up to 73' AGL/313' MSL.

Tree 575' from DER, 512' left of centerline, 4' AGL/265' MSL.

Trees beginning 653' from DER, 170' left of centerline, up to 4' AGL/266' MSL.

Catenary, pole, tree beginning 1046' from DER, 52' left of centerline, up to 42' AGL/284' MSL.

Trees beginning 1123' from DER, 133' left of centerline, up to 83' AGL/327' MSL.

Trees beginning 1129' from DER, 12' right of centerline, up to 82' AGL/325' MSL.

Tree 1256' from DER, 397' left of centerline, 80' AGL/329' MSL.

Trees beginning 1880' from DER, 34' left of centerline, up to 97' AGL/352' MSL.

Tree 1990' from DER, 75' right of centerline, 102' AGL/341' MSL.

Trees beginning 2184' from DER, 4' right of centerline, up to 109' AGL/344' MSL.

Trees beginning 2546' from DER, 162' left of centerline, up to 98' AGL/356' MSL.

Tree 2963' from DER, 1188' right of centerline, 82' AGL/355' MSL.

Trees beginning 2973' from DER, 1191' right of centerline, up to 86' AGL/364' MSL.

Trees beginning 4046' from DER, 1574' right of centerline, up to 119' AGL/379' MSL.

Tree 4818' from DER, 1704' right of centerline, 118' AGL/385' MSL.

Tree 1 NM from DER, 2106' right of centerline, 96' AGL/590' MSL.

PERRYVILLE, AK

PERRYVILLE (PEV) (PAPE)

TAKEOFF MINIMUMS AND (OBSTACLE) DEPARTURE PROCEDURES

AMDT 2 08NOV18 (18312) (FAA)

TAKEOFF MINIMUMS:

Rwy 2, NA-obstacles.

DEPARTURE PROCEDURE:

Rwy 20, Use CILAC (RNAV) DEPARTURE.

TAKEOFF OBSTACLE NOTES:

Rwy 20, tree 52' from DER, 264' right of centerline, 50' AGL/67' MSL.

Trees beginning 83' from DER, 17' right of centerline, up to 50' AGL/99' MSL.

Trees beginning 103' from DER, 190' left of centerline, up to 50' AGL/50' MSL.

Trees beginning 549' from DER, 86' left of centerline, up to 50' AGL/64' MSL.

Vehicle 1567' from DER, 156' left of centerline, 15' AGL/64' MSL.

Tree 1690' from DER, 54' left of centerline, 50' AGL/70' MSL.

Trees beginning 1937' from DER, 35' right of centerline, up to 50' AGL/149' MSL.

Tree 2385' from DER, 125' left of centerline, 50' AGL/90' MSL.

Tree 2633' from DER, 301' left of centerline, 50' AGL/100' MSL.

Trees beginning 2666' from DER, 303' right of centerline, up to 50' AGL/249' MSL.

Tree 2831' from DER, 21' left of centerline, 50' AGL/113' MSL.

Trees beginning 2850' from DER, 322' left of centerline, up to 50' AGL/149' MSL.

Trees beginning 4867' from DER, 1170' left of centerline, up to 50' AGL/349' MSL.

TAKEOFF MINIMUMS, (OBSTACLE) DEPARTURE PROCEDURES, AND DIVERSE VECTOR AREA (RADAR VECTORS)

24025

AK

TAKEOFF MINIMUMS, (OBSTACLE) DEPARTURE PROCEDURES, AND DIVERSE VECTOR AREA (RADAR VECTORS)

24025

PETERSBURG, AK

PETERSBURG JAMES A JOHNSON (PSG) (PAPG)
TAKEOFF MINIMUMS AND (OBSTACLE) DEPARTURE PROCEDURES
AMDT 6 27JUN13 (13178) (FAA)
DEPARTURE PROCEDURE:
Use PETERSBURG DEPARTURE.

PILOT POINT, AK

PILOT POINT (PNP) (PAPN)
TAKEOFF MINIMUMS AND (OBSTACLE) DEPARTURE PROCEDURES
ORIG 25DEC03 (03359) (FAA)
DEPARTURE PROCEDURE:
Use ZILKO RNAV DEPARTURE.

PLATINUM, AK

PLATINUM (PTU) (PAPM)
TAKEOFF MINIMUMS AND (OBSTACLE) DEPARTURE PROCEDURES
AMDT 2 17AUG17 (17229) (FAA)
TAKEOFF MINIMUMS:
Rwy 14, std. w/min climb of 640' per NM to 2800 or 2400-3 for VCOA.
DEPARTURE PROCEDURE:
Rwy 32, climb heading 324° to 1500 before proceeding on course.
VCOA:
Rwy 14, obtain ATC approval for VCOA when requesting IFR clearance, climb in visual conditions to cross Platinum airport at or above 2300 before proceeding on course.
TAKEOFF OBSTACLE NOTES:
Rwy 14, vehicles on road beginning 30' from DER, crossing centerline, up to 15' AGL/36' MSL.
Bush 71' from DER, 242' right of centerline, 2' AGL/27' MSL.
Vehicles on road beginning 183' from DER, 493' left of centerline, up to 15' AGL/31' MSL.

POINT HOPE, AK

POINT HOPE (PHO) (PAPO)
TAKEOFF MINIMUMS AND (OBSTACLE) DEPARTURE PROCEDURES
AMDT 1 17OCT13 (13290) (FAA)
TAKEOFF OBSTACLE NOTES:
Rwy 1, barge/iceberg 778' from DER, 632' left of centerline, 50' AGL/50' MSL.
Lights 16' from DER, 37' left and right of centerline, 3' AGL/20' MSL.
Rwy 19, barge/iceberg 912' from DER, 237' left of centerline, 50' AGL/50' MSL.
Lights 2' from DER, 38' left and right of centerline, 3' AGL/21' MSL.

PORT ALSWORTH, AK

WILDER RUNWAY (05K) (PAKX)
TAKEOFF MINIMUMS AND (OBSTACLE) DEPARTURE PROCEDURES
ORIG 07OCT21 (21336) (FAA)
TAKEOFF MINIMUMS:
Rwy 6R, NA-Obstacles.
DEPARTURE PROCEDURE:
Rwy 24L, use MARVN DEPARTURE (RNAV).
TAKEOFF OBSTACLE NOTES:
Rwy 24L, trees beginning abeam DER, 93' left of centerline, up to 80' AGL/380' MSL.
Trees beginning abeam DER, 74' right of centerline, up to 80' AGL/380' MSL.

PORT HEIDEN, AK

PORT HEIDEN (PTH) (PAPH)
TAKEOFF MINIMUMS AND (OBSTACLE) DEPARTURE PROCEDURES
AMDT 3 05DEC19 (19339) (FAA)
DEPARTURE PROCEDURE:
Use ITAWU DEPARTURE.

25 JAN 2024 to 21 MAR 2024

25 JAN 2024 to 21 MAR 2024

TAKEOFF MINIMUMS, (OBSTACLE) DEPARTURE PROCEDURES, AND DIVERSE VECTOR AREA (RADAR VECTORS)

24025

AK

TAKEOFF MINIMUMS, (OBSTACLE) DEPARTURE PROCEDURES, AND DIVERSE VECTOR AREA (RADAR VECTORS)

24025

QUINHAGAK, AK

QUINHAGAK (AQH) (PAQH)

TAKEOFF MINIMUMS AND (OBSTACLE) DEPARTURE PROCEDURES

AMDT 1 31MAR16 (22139) (FAA)

TAKEOFF MINIMUMS:

Rwy 12, std. w/min. climb of 255' per NM to 4200, or 1400-3 for climb in visual conditions.

VCOA:

Rwy 12, obtain ATC approval for VCOA when requesting IFR clearance. Climb in visual conditions to cross Quinhagak airport at or above 1300 before proceeding on course.

TAKEOFF OBSTACLE NOTES:

Rwy 12, pole 19' from DER, 279' right of centerline, 15' AGL/46' MSL.

Trees beginning 225' from DER, 151' right of centerline, up to 15' AGL/64' MSL.

Rwy 30, trees beginning 251' from DER, 433' left of centerline, up to 15' AGL/64' MSL.

Trees beginning 834' from DER, 674' right of centerline, up to 15' AGL/64' MSL.

RUBY, AK

RUBY (RBY) (PARY)

TAKEOFF MINIMUMS AND (OBSTACLE) DEPARTURE PROCEDURES

AMDT 1 18NOV10 (10322) (FAA)

TAKEOFF MINIMUMS:

Rwy 3, std. w/ min. climb of 340' per NM to 4000 or 1900-2½ for climb in visual conditions.

Rwy 21, std. w/min. climb of 566' per NM to 4000 or 1900-2½ for climb in visual conditions.

DEPARTURE PROCEDURE:

Rwy 3, climb heading 031° to 1400 then climbing right turn heading 282° to intercept GAL VOR/DME-072 to GAL VOR/DME, or for climb in visual conditions cross Ruby at or above 2400 before proceeding on course.

Rwy 21, climb heading 211° to 1300 then climbing right turn heading 282° to intercept GAL VOR/DME-072 to GAL VOR/DME, or for climb in visual conditions cross Ruby at or above 2400 before proceeding on course.

TAKEOFF OBSTACLE NOTES:

Rwy 3, trees beginning 177' from DER, 150' left of centerline, up to 50' AGL/714' MSL.

Rwy 21, trees beginning 1299' from DER, 79' left of centerline, up to 50' AGL/874' MSL.

Rising terrain beginning 1895' from DER, 64' left of centerline, up to 801' MSL.

Tree 1272' from DER, on centerline, 27' AGL/726' MSL.

Trees beginning 122' from DER, 400' right of centerline, up to 50' AGL/881' MSL.

Rising terrain 4724' from DER, 101' right of centerline, up to 827' MSL.

RUSSIAN MISSION, AK

RUSSIAN MISSION (RSH) (PARS)

TAKEOFF MINIMUMS AND (OBSTACLE) DEPARTURE PROCEDURES

AMDT 3 02DEC21 (21336) (FAA)

TAKEOFF MINIMUMS:

Rwy 18, 700-3 w/min. climb of 370' per NM to 2400 or 2000-3 for VCOA.

Rwy 36, 500-2 w/min. climb of 370' per NM to 3700 or 2000-3 for VCOA.

DEPARTURE PROCEDURE:

Rwy 36, climb on heading 356° to 500 before turning left.

VCOA:

Obtain ATC approval for VCOA when requesting IFR clearance. Climb in visual conditions to cross Russian Mission airport at or above 1900 before proceeding on course.

TAKEOFF OBSTACLE NOTES:

Rwy 18, trees beginning 54' from DER, 143' right of centerline, up to 93' MSL.

Trees beginning 642' from DER, 659' right of centerline, up to 221' MSL.

Tree 935' from DER, 654' right of centerline, 228' MSL.

Tree 947' from DER, 749' right of centerline, 246' MSL.

Trees beginning 1007' from DER, 446' right of centerline, up to 257' MSL.

Trees beginning 1455' from DER, 198' left of centerline, up to 126' MSL.

Trees beginning 1886' from DER, 159' left of centerline, up to 139' MSL.

Trees beginning 2155' from DER, 169' left of centerline, up to 144' MSL.

Rwy 36, lighting 2' from DER, 99' left of centerline, 2' AGL/60' MSL.

Tree 90' from DER, 165' right of centerline, 69' MSL.

Trees beginning 121' from DER, 161' left of centerline, up to 71' MSL.

Tree, vehicle on roadway beginning 128' from DER, 20' right of centerline, up to 76' MSL.

Trees beginning 181' from DER, 161' left of centerline, up to 74' MSL.

Trees beginning 283' from DER, 70' left of centerline, up to 76' MSL.

Tree, building beginning 367' from DER, 17' right of centerline, up to 82' MSL.

Trees beginning 490' from DER, 20' right of centerline, up to 85' MSL.

Tree 570' from DER, 81' left of centerline, 77' MSL.

Trees beginning 610' from DER, 33' left of centerline, up to 79' MSL.

Trees beginning 672' from DER, 42' right of centerline, up to 89' MSL.

Trees beginning 689' from DER, 5' left of centerline, up to 82' MSL.

Trees beginning 709' from DER, 13' right of centerline, up to 94' MSL.

Bush 1790' from DER, 902' left of centerline, 110' MSL.

Building 1865' from DER, 927' left of centerline, 17' AGL/131' MSL.

Tree, building beginning 1905' from DER, 854' left of centerline, up to 145' MSL.

Tree 2021' from DER, 687' left of centerline, 146' MSL.

Tree, building beginning 2028' from DER, 804' left of centerline, up to 160' MSL.

CON'T

TAKEOFF MINIMUMS, (OBSTACLE) DEPARTURE PROCEDURES, AND DIVERSE VECTOR AREA (RADAR VECTORS)

24025

TAKEOFF MINIMUMS, (OBSTACLE) DEPARTURE PROCEDURES, AND DIVERSE VECTOR AREA (RADAR VECTORS)

24025

RUSSIAN MISSION, AK (CON'T)

RUSSIAN MISSION (RSH) (PARS) (CON'T)

Rwy 36 (CON'T), trees beginning 2156' from DER, 472' left of centerline, up to 206' MSL.

Trees beginning 2302' from DER, 457' left of centerline, up to 249' MSL.

Tree 2391' from DER, 635' left of centerline, 250' MSL.

Trees beginning 2452' from DER, 479' left of centerline, up to 260' MSL.

Tree 2533' from DER, 652' left of centerline, 272' MSL.

Tank 2539' from DER, 1013' left of centerline, 19' AGL/275' MSL.

Tree 2611' from DER, 756' left of centerline, 298' MSL.

Tree 2622' from DER, 950' left of centerline, 303' MSL.

Trees beginning 2696' from DER, 665' left of centerline, up to 308' MSL.

Trees beginning 2835' from DER, 682' left of centerline, up to 336' MSL.

Tree 2966' from DER, 1235' left of centerline, 356' MSL.

Trees beginning 3068' from DER, 884' left of centerline, up to 358' MSL.

ST. GEORGE, AK

ST GEORGE (PBV) (PAPB)

TAKEOFF MINIMUMS AND (OBSTACLE) DEPARTURE PROCEDURES

AMDT 2 10NOV16 (16315) (FAA)

TAKEOFF MINIMUMS:

Rwy 11, 600-2% or std. w/min. climb of 405' per NM to 900.

Rwy 29, 600-2% or std. w/min. climb of 295' per NM to 800.

DEPARTURE PROCEDURE:

Rwy 11, climb on a heading between 107° CW 250° from DER to 1200 before proceeding on course.

Rwy 29, climb on heading 287° to 1200 before turning right.

TAKEOFF OBSTACLE NOTES:

Rwy 11, ground 183' from DER, 474' left of centerline, 138' MSL.

Ground 1.6 NM from DER, crossing centerline, up to 556' MSL.

Ground 1.8 NM from DER, on centerline, 626' MSL.

Ground 1.8 NM from DER, 874' left of centerline, 673' MSL.

Ground 2.1 NM from DER, 4005' left of centerline, 700' MSL.

Rwy 29, ground 196' from DER, 495' right of centerline, 144' MSL.

Antenna 1023' from DER, 417' right of centerline, 17' AGL/165' MSL.

Ground 2.2 NM from DER, 2511' right of centerline, 635' MSL.

ST. MARY'S, AK

ST MARY'S (KSM) (PASM)

TAKEOFF MINIMUMS AND (OBSTACLE) DEPARTURE PROCEDURE

AMDT 2 17JUN21 (21168) (FAA)

TAKEOFF MINIMUMS:

Rwy 6, 400-1% or std. w/min. climb of 466' per NM to 900.

Rwy 17, 300-1% or std. w/min. climb of 365' per NM to 700.

Rwy 24, 300-1 or std. w/min. climb of 430' per NM to 600.

DEPARTURE PROCEDURE:

Rwy 17, climb on heading 170° to 800 before turning left.

TAKEOFF OBSTACLE NOTES:

Rwy 6, NAVAID 84' from DER, 238' right of centerline, 29' AGL/316' MSL, tower 1 NM from DER, 2179' right of centerline, 137' AGL/684' MSL.

Rwy 17, vehicle on road 99' from DER, 489' left and right of centerline, 321' MSL, tree 5865' from DER, 1935' left of centerline, 15' AGL/514' MSL.

Rwy 24, tree 3759' from DER, 19' left of centerline, 15' AGL/514' MSL.

Rwy 35, vegetation 4' from DER, 203' left of centerline, 295' MSL.

ST. MICHAEL, AK

ST MICHAEL (SMK) (PAMK)

TAKEOFF MINIMUMS AND (OBSTACLE) DEPARTURE PROCEDURES

AMDT 2 05JAN17 (17005) (FAA)

DEPARTURE PROCEDURE:

Rwy 20, climb heading 196° to 800' before turning right.

TAKEOFF OBSTACLE NOTES:

Rwy 20, lighted windsock 98' from DER, 423' right of centerline, 115' MSL.

Vehicle on road 807' from DER, 143' left of centerline, up to 120' MSL.

Pole 992' from DER, 556' right of centerline, 12' AGL/144' MSL.

Transmission line towers beginning 1023' from DER, 593' right of centerline, up to 33' AGL/145' MSL.

Transmission line tower 1906' from DER, 792' left of centerline, 33' AGL/154' MSL.

Transmission line towers beginning 1912' from DER, 96' right of centerline, up to 32' AGL/159' MSL.

TAKEOFF MINIMUMS, (OBSTACLE) DEPARTURE PROCEDURES, AND DIVERSE VECTOR AREA (RADAR VECTORS)

24025

TAKEOFF MINIMUMS, (OBSTACLE) DEPARTURE PROCEDURES, AND DIVERSE VECTOR AREA (RADAR VECTORS)

24025

ST. PAUL ISLAND, AK

ST PAUL ISLAND (SNP) (PASN)

TAKEOFF MINIMUMS AND (OBSTACLE) DEPARTURE PROCEDURES

AMDT 3 18NOV10 (10322) (FAA)

DEPARTURE PROCEDURE:

Rwy 18, climb heading 180° to 800 before proceeding on course.**Rwy 36**, climb heading 360° to 600 before proceeding on course.

TAKEOFF OBSTACLE NOTES:

Rwy 36, terrain beginning 217' from DER, 84' left of centerline up to 79' MSL.

SAND POINT, AK

SAND POINT (SDP) (PASD)

TAKEOFF MINIMUMS AND (OBSTACLE) DEPARTURE PROCEDURES

AMDT 4A 13SEP18 (18256) (FAA)

DEPARTURE PROCEDURE:

Use BORLAND DEPARTURE.

SAVOONGA, AK

SAVOONGA (SVA) (PASA)

TAKEOFF MINIMUMS AND (OBSTACLE) DEPARTURE PROCEDURES

AMDT 1 29JUL10 (10210) (FAA)

TAKEOFF MINIMUMS:

Rwy 23, std. w/min climb of 250' per NM to 1000, or 1600-2½ for climb in visual conditions.

DEPARTURE PROCEDURE:

Rwy 5, aircraft departing via ULL R-260 CW R-080 climb on course, all others climb via ULL R-059 to 2200 before turning South.**Rwy 23**, aircraft departing via ULL R-260 CW R-080 climb on course. All others climbing right turn direct ULL VOR/DME then via ULL R-059 to 2200 before turning South. For climb in visual conditions: cross Savoonga Airport at or above 1500, then proceed on ULL R-059 to 2200.

TAKEOFF OBSTACLE NOTES:

Rwy 23, trees 2791' from DER, 140' left of centerline, 20' AGL/140' MSL.

Rising terrain beginning 590' from DER, 351' left of centerline, up to 99' MSL.

SCAMMON BAY, AK

SCAMMON BAY (SCM) (PACM)

TAKEOFF MINIMUMS AND (OBSTACLE) DEPARTURE PROCEDURES

AMDT 2 10NOV16 (16315) (FAA)

TAKEOFF MINIMUMS:

Rwy 10, std. w/min. climb of 410' per NM to 1900, or 2100-3 for VCOA.**Rwy 28**, std. w/min. climb of 230' per NM to 2300, or 2100-3 for VCOA.

DEPARTURE PROCEDURE:

Rwy 10, climb heading 101° to 1900 before proceeding on course.**Rwy 28**, climb heading 281° to 2300 before turning left.

VCOA:

Obtain ATC approval for VCOA when requesting IFR clearance. Climb in visual conditions to cross Scammon Bay airport at or above 2000 before proceeding on course.

TAKEOFF OBSTACLE NOTES:

Rwy 10, signs 10' from DER, both 54' left and right of centerline, 4' AGL/20' MSL.

Bushes beginning 642' from DER, 670' right of centerline, up to 37' MSL.

Terrain beginning 1286' from DER, 841' right of centerline, up to 60' MSL.

Bush 1485' from DER, 874' right of centerline, 69' MSL.

Bushes and terrain beginning 1.1 NM from DER, 732' right of centerline, up to 373' MSL.

Terrain beginning 1.4 NM from DER, 1102' left of centerline, up to 269' MSL.

Bushes and terrain beginning 1.4 NM from DER, 697' right of centerline, up to 389' MSL.

Terrain beginning 1.4 NM from DER, 1024' left of centerline, up to 325' MSL.

Bushes and terrain beginning 1.4 NM from DER, 636' right of centerline, up to 596' MSL.

Bushes and terrain beginning 1.8 NM from DER, 1670' left of centerline, up to 430' MSL.

Terrain beginning 1.9 NM from DER, crossing centerline, up to 641' MSL.

Rwy 28, vehicles on road beginning 151' from DER, 271' left of centerline, up to 26' MSL.

SELAWIK, AK

SELAWIK (WLK) (PASK)

TAKEOFF MINIMUMS AND (OBSTACLE) DEPARTURE PROCEDURES

AMDT 1A 29MAY14 (14149) (FAA)

TAKEOFF OBSTACLE NOTES:

Rwy 4, multiple bushes beginning 176' from DER, 429' left of centerline, up to 18' AGL/18' MSL.**Rwy 22**, antenna on building, 1040' from DER, 448' right of centerline, 30' AGL/ 47' MSL.**Rwy 27**, multiple antennas and buildings beginning 270' from DER, right and left of centerline, up to 108' AGL/125' MSL.

Bridge 2148' from DER, 249' right of centerline, 60' AGL/90' MSL.

Wind turbines beginning 3310' from DER, 1194' right of centerline, up to 110' AGL/165' MSL.

TAKEOFF MINIMUMS, (OBSTACLE) DEPARTURE PROCEDURES, AND DIVERSE VECTOR AREA (RADAR VECTORS)

24025

TAKEOFF MINIMUMS, (OBSTACLE) DEPARTURE PROCEDURES, AND DIVERSE VECTOR AREA (RADAR VECTORS)

24025

SEWARD, AK

SEWARD (SWD) (PAWD)

TAKEOFF MINIMUMS AND (OBSTACLE) DEPARTURE PROCEDURES

ORIG-A 20SEP12 (12264) (FAA)

DEPARTURE PROCEDURE:

Rwy 13, Use SEWARD DEPARTURE.**Rwys 16, 31, 34**, NA - Terrain.

SHAGELUK, AK

SHAGELUK (SHX)

TAKEOFF MINIMUMS AND (OBSTACLE) DEPARTURE PROCEDURES

ORIG 20NOV08 (08325) (FAA)

DEPARTURE PROCEDURE:

Rwy 16, climb heading 180° to 1400 before turning left.**Rwy 34**, climb heading 345° to 1200 before turning right.

TAKEOFF OBSTACLE NOTES:

Rwy 16, vehicles on road, beginning 160' from DER, 153' right of centerline, up to 15' AGL/93' MSL.

Bush 322' from DER, 9' left of centerline, 9' AGL/87' MSL.

Trees beginning 2' from DER, 393' right of centerline, up to 40' AGL/118' MSL.

Trees beginning 720' from DER, 122' left of centerline, up to 53' AGL/131' MSL.

Rwy34, trees beginning 34' from DER, 386' right of centerline, up to 53' AGL/131' MSL.

SHAKTOOLIK, AK

SHAKTOOLIK (2C7) (PFSH)

TAKEOFF MINIMUMS AND (OBSTACLE) DEPARTURE PROCEDURES

AMDT 1 15AUG19 (19227) (FAA)

DEPARTURE PROCEDURE:

Rwy 15, climb on heading 147° to 1300 before turning east.

TAKEOFF OBSTACLE NOTES:

Rwy 15, building 199' from DER, 483' left of centerline, 41' AGL/46' MSL.

Buildings beginning 204' from DER, 483' left of centerline, up to 50' AGL/55' MSL.

SHISHMAREF, AK

SHISHMAREF (SHH) (PASH)

TAKEOFF MINIMUMS AND (OBSTACLE) DEPARTURE PROCEDURES

AMDT 1 05OCT23 (23278) (FAA)

TAKEOFF OBSTACLE NOTES:

Rwy 5, vehicle on road, fence beginning 44' from DER, 300' left of centerline, up to 26' MSL.

Building 83' from DER, 333' right of centerline, 10' AGL/19' MSL.

Tank 382' from DER, 455' left of centerline, 26' AGL/33' MSL.

Antenna, building beginning 773' from DER, 492' left of centerline, up to 63' AGL/74' MSL.

Pole, buildings, tank beginning 811' from DER, 604' left of centerline, up to 68' AGL/81' MSL.

Rwy 23, vehicle on road 23' from DER, 220' right of centerline, 28' MSL.

SHUNGNAK, AK

SHUNGNAK (SHG) (PAGH)

TAKEOFF MINIMUMS AND (OBSTACLE) DEPARTURE PROCEDURES

AMDT 1 10OCT19 (19283) (FAA)

DEPARTURE PROCEDURE:

Rwys 10, 28, climbing right turn direct AMF NDB.

TAKEOFF OBSTACLE NOTES:

Rwy 10, lighting beginning 9' from DER, 20' left of centerline, up to 3' AGL/207' MSL.

Lighting beginning 10' from DER, 20' right of centerline, up to 2' AGL/207' MSL.

Vegetation, trees beginning 58' from DER, 277' right of centerline, up to 219' MSL.

Trees, road beginning 103' from DER, 111' right of centerline, up to 237' MSL.

Trees beginning 838' from DER, 30' left of centerline, up to 234' MSL.

Tree 1180' from DER, 589' left of centerline, 241' MSL.

Tree 1218' from DER, 608' left of centerline, 255' MSL.

Rwy 28, lighting beginning 9' from DER, 20' right of centerline, up to 3' AGL/176' MSL.

Lighting beginning 9' from DER, 19' left of centerline, up to 2' AGL/176' MSL.

TAKEOFF MINIMUMS, (OBSTACLE) DEPARTURE PROCEDURES, AND DIVERSE VECTOR AREA (RADAR VECTORS)

24025

AK

TAKEOFF MINIMUMS, (OBSTACLE) DEPARTURE PROCEDURES, AND DIVERSE VECTOR AREA (RADAR VECTORS)

24025

SITKA, AK

SITKA ROCKY GUTIERREZ (SIT) (PASI)

TAKEOFF MINIMUMS AND (OBSTACLE) DEPARTURE PROCEDURES

AMDT 3 18JAN07 (07018) (FAA)

DEPARTURE PROCEDURE:

Use BIORKA DEPARTURE.

SLEETMUTE, AK

SLEETMUTE (SLQ) (PASL)

TAKEOFF MINIMUMS AND (OBSTACLE) DEPARTURE PROCEDURES

ORIG 31DEC20 (20366) (FAA)

TAKEOFF MINIMUMS:

Rwy 33, NA - Terrain.

DEPARTURE PROCEDURE:

Rwy 15, use SPARREVOHN DEPARTURE.

TAKEOFF OBSTACLE NOTES:

Rwy 15, sign at DER, 67' right of centerline, 194' MSL.

Sign at DER, 69' left of centerline, 194' MSL.

Trees beginning 2' from DER, 187' left of centerline, up to 219' MSL.

Tree 30' from DER, 482' right of centerline, 240' MSL.

Trees beginning 124' from DER, 174' right of centerline, up to 245' MSL.

Tree 143' from DER, 496' right of centerline, 54' AGL/247' MSL.

Trees beginning 162' from DER, 271' left of centerline, up to 241' MSL.

Trees beginning 256' from DER, 21' right of centerline, up to 249' MSL.

Tree 292' from DER, 343' left of centerline, 247' MSL.

Trees beginning 368' from DER, 448' right of centerline, up to 253' MSL.

Trees beginning 395' from DER, 333' left of centerline, up to 248' MSL.

Tree 497' from DER, 570' right of centerline, 254' MSL.

Trees beginning 524' from DER, 19' right of centerline, up to 255' MSL.

Trees beginning 635' from DER, 268' left of centerline, up to 254' MSL.

Tree 692' from DER, 477' right of centerline, 256' MSL.

Trees beginning 719' from DER, 125' right of centerline, up to 263' MSL.

Trees beginning 724' from DER, 423' left of centerline, up to 256' MSL.

Trees beginning 920' from DER, 58' left of centerline, up to 268' MSL.

Trees beginning 1734' from DER, 43' right of centerline, up to 277' MSL.

Trees beginning 1975' from DER, 171' right of centerline, up to 292' MSL.

Trees beginning 2173' from DER, 22' left of centerline, up to 280' MSL.

Trees beginning 2198' from DER, 22' right of centerline, up to 294' MSL.

Trees beginning 3209' from DER, 66' right of centerline, up to 296' MSL.

Trees beginning 1.3 NM from DER, 2558' right of centerline, up to 433' MSL.

Tree 1.3 NM from DER, 2581' right of centerline, 454' MSL.

Trees beginning 1.3 NM from DER, 2515' right of centerline, up to 495' MSL.

Trees beginning 1.4 NM from DER, 2607' right of centerline, up to 509' MSL.

Trees beginning 1.4 NM from DER, 2351' right of centerline, up to 524' MSL.

SOLDOTNA, AK

SOLDOTNA (SXQ) (PASX)

TAKEOFF MINIMUMS AND (OBSTACLE) DEPARTURE PROCEDURES

AMDT 2A 20JUN19 (19171) (FAA)

TAKEOFF MINIMUMS:

Rwy 7, 300-2¼ or std. w/min climb of 375' per NM to 400.**Rwy 25**, 300-1¾.

DEPARTURE PROCEDURE:

Rwy 7, climbing left turn on a heading between 256° clockwise to 054° from DER or climbing right turn on a heading between 179° clockwise to 254° from DER.**Rwy 25**, climb heading 255° to 800, then climb on a heading between 164° clockwise to 069°.

TAKEOFF OBSTACLE NOTES:

Rwy 7, tree 51' from DER, 439' right of centerline, 40' AGL/147' MSL.

Transmission line beginning 195' from DER, 362' right of centerline, up to 66' AGL/168' MSL.

Multiple trees beginning 1243' from DER, 450' right of centerline, up to 53' AGL/173' MSL.

Tree 1381' from DER, 699' right of centerline, 54' AGL/179' MSL.

Tree 1393' from DER, 558' right of centerline, 59' AGL/184' MSL.

Multiple trees beginning 1470' from DER, 168' right of centerline, up to 86' AGL/237' MSL.

Tree 1985' from DER, 536' left of centerline, 59' AGL/162' MSL.

Transmission line beginning 1995' from DER, 165' right of centerline, up to 86' AGL/257' MSL.

Tree 2098' from DER, 646' left of centerline, 63' AGL/165' MSL.

Transmission line beginning 2544' from DER, 476' right of centerline, up to 79' AGL/258' MSL.

Tree 2658' from DER, 630' left of centerline, 76' AGL/179' MSL.

Transmission line beginning 2788' from DER, 350' right of centerline, up to 82' AGL/260' MSL.

Multiple trees beginning 2932' from DER, 766' right of centerline, up to 83' AGL/264' MSL.

Tree 3017' from DER, 133' left of centerline, 84' AGL/188' MSL.

Multiple trees beginning 3303' from DER, 992' right of centerline, up to 94' AGL/266' MSL.

Tree 1.6 NM from DER, 2879' left of centerline, 70' AGL/356' MSL.

CON'T

TAKEOFF MINIMUMS, (OBSTACLE) DEPARTURE PROCEDURES, AND DIVERSE VECTOR AREA (RADAR VECTORS)

24025

TAKEOFF MINIMUMS, (OBSTACLE) DEPARTURE PROCEDURES, AND DIVERSE VECTOR AREA (RADAR VECTORS)

24025

SOLDOTNA, AK (CON'T)

SOLDOTNA (SXQ) (PASX) (CON'T)

Rwy 7 (CON'T), tree 1.6 NM from DER, 2838' left of centerline, 83' AGL/374' MSL.
 Tree 1.6 NM from DER, 3259' left of centerline, 81' AGL/390' MSL.
Rwy 25, tree 102' from DER, 425' left of centerline, 13' AGL/111' MSL.
 Tree 177' from DER, 525' left of centerline, 34' AGL/129' MSL.
 Tree 189' from DER, 493' left of centerline, 35' AGL/130' MSL.
 Multiple trees beginning 290' from DER, 450' left of centerline, up to 46' AGL/142' MSL.
 Transmission line beginning 490' from DER, 193' left of centerline, up to 54' AGL/149' MSL.
 Tree 1043' from DER, 45' right of centerline, 35' AGL/126' MSL.
 Tree 1045' from DER, 83' right of centerline, 39' AGL/132' MSL.
 Tree 1052' from DER, 301' right of centerline, 41' AGL/133' MSL.
 Pole beginning 1061' from DER, 54' right of centerline, up to 43' AGL/134' MSL.
 Multiple trees beginning 1117' from DER, 71' right of centerline, up to 52' AGL/145' MSL.
 Multiple trees beginning 1209' from DER, 1' left of centerline, up to 61' AGL/174' MSL.
 Multiple trees beginning 1343' from DER, 23' right of centerline, up to 66' AGL/164' MSL.
 Transmission line beginning 1474' from DER, 97' left of centerline, up to 74' AGL/236' MSL.
 Multiple trees beginning 1873' from DER, 81' left of centerline, up to 59' AGL/261' MSL.
 Transmission line, pole beginning 2016' from DER, 392' left of centerline, up to 69' AGL/275' MSL.
 Tree 2443' from DER, 365' right of centerline, 87' AGL/166' MSL.
 Multiple trees beginning 2525' from DER, 338' left of centerline, up to 87' AGL/302' MSL.
 Tree 1.4 NM from DER, 2803' left of centerline, 85' AGL/338' MSL.
 Tree 1.5 NM from DER, 2800' left of centerline, 84' AGL/334' MSL.

SOUTH NAKNEK, AK

SOUTH NAKNEK NR 2 (WSN) (PFWS)

TAKEOFF MINIMUMS AND (OBSTACLE) DEPARTURE PROCEDURES

ORIG 26MAY16 (16147) (FAA)

TAKEOFF MINIMUMS:

Rwy 5, 23, NA.

TAKEOFF OBSTACLE NOTES:

Rwy 13, trees beginning 930' from DER, 268' left of centerline, up to 15' AGL/186' MSL.
 Bushes beginning 240' from DER, 61' left of centerline, up to 13' AGL/186' MSL.
 Bush 246' from DER, 18' right of centerline, 13' AGL/162' MSL.
Rwy 31, trees beginning 29' from DER, 143' left of centerline, up to 15' AGL/174' MSL.
 Poles beginning 204' from DER, 359' right of centerline, up to 43' AGL/177' MSL.
 Catenary 217' from DER, 451' right of centerline, 35' AGL/170' MSL.
 Trees beginning 210' from DER, 111' right of centerline, up to 34' AGL/172' MSL.
 Vehicles on road 211' from DER, 233' right of centerline, 15' AGL/167' MSL.

SPARREVOHN LRRS (SVW) (PASV)

SPARREVOHN, AK

TAKEOFF MINIMUMS AND (OBSTACLE) DEPARTURE PROCEDURES

ORIG 19MAY22 (22139) (USAF)

TAKE-OFF MINIMUMS:

Rwy 16, 2200-3 for climb in visual conditions.

Rwy 34, NA.

DEPARTURE PROCEDURE:

Diverse departures NA.

CAUTION: Uncontrolled airspace below 700' AGL within 3 NM of Sparrevohn airport.

Rwy 16, obtain ATC approval for VCOA when requesting IFR clearance. Climb in visual conditions to cross Sparrevohn LRRS at or above 3600' MSL before proceeding on course. Remain within 3 NM of Sparrevohn LRRS during climb in visual conditions.

Rwy 34, NA.

TAKEOFF OBSTACLE NOTES:

Rwy 16, terrain 1415' from DER, 850' left of cntrn, 1493' MSL.
 Terrain 1124' from DER, 801' left of cntrn, 1513' MSL.
 Terrain 196' from DER, 329' right of cntrn, 1404' MSL.

25 JAN 2024 to 21 MAR 2024

25 JAN 2024 to 21 MAR 2024

TAKEOFF MINIMUMS, (OBSTACLE) DEPARTURE PROCEDURES, AND DIVERSE VECTOR AREA (RADAR VECTORS)

24025

AK

TAKEOFF MINIMUMS, (OBSTACLE) DEPARTURE PROCEDURES, AND DIVERSE VECTOR AREA (RADAR VECTORS)

24025

TALKEETNA, AK

TALKEETNA (TKA) (PATK)

TAKEOFF MINIMUMS AND (OBSTACLE) DEPARTURE PROCEDURES

AMDT 3 17AUG17 (17229) (FAA)

TAKEOFF MINIMUMS:

Rwy 19, 300-1¼ or std. w/min. climb of 600' per NM to 600.

DEPARTURE PROCEDURE:

Rwy 1, Climb heading 011° to 1000 then climbing left turn direct TKA VOR/DME, thence...

Rwy 19, Climb heading 191° to 1900 then climbing right turn direct TKA VOR/DME, thence...

...continue climb-in-hold in TKA VOR/DME holding pattern (hold South, left turn, 352° inbound) to cross TKA VOR/DME at or above MEA/MCA for route of flight before proceeding on course.

TAKEOFF OBSTACLE NOTES:

Rwy 1, tree 38' from DER, 499' right of centerline, 53' AGL/411' MSL.

Trees beginning 71' from DER, 385' left of centerline, up to 55' AGL/411' MSL.

Tree 178' from DER, 494' right of centerline, 58' AGL/417' MSL.

Trees beginning 270' from DER, 275' left of centerline, up to 81' AGL/443' MSL.

Trees beginning 371' from DER, 354' right of centerline, up to 72' AGL/433' MSL.

Trees beginning 476' from DER, 302' left of centerline, up to 86' AGL/448' MSL.

Trees beginning 525' from DER, 322' right of centerline, up to 84' AGL/445' MSL.

Tree 584' from DER, 552' right of centerline, 86' AGL/447' MSL.

Trees beginning 690' from DER, 386' right of centerline, up to 87' AGL/448' MSL.

Trees beginning 741' from DER, 403' left of centerline, up to 87' AGL/449' MSL.

Trees beginning 781' from DER, 385' right of centerline, up to 88' AGL/449' MSL.

Trees beginning 884' from DER, 148' right of centerline, up to 89' AGL/451' MSL.

Trees beginning 912' from DER, 345' left of centerline, up to 91' AGL/451' MSL.

Trees beginning 1109' from DER, 49' left of centerline, up to 92' AGL/454' MSL.

Trees beginning 2144' from DER, 106' left of centerline, up to 99' AGL/461' MSL.

Trees beginning 2179' from DER, 147' right of centerline, up to 88' AGL/452' MSL.

Trees beginning 2342' from DER, 606' right of centerline, up to 92' AGL/457' MSL.

Trees beginning 2371' from DER, 32' right of centerline, up to 94' AGL/460' MSL.

Trees beginning 2996' from DER, 183' right of centerline, up to 97' AGL/464' MSL.

Tree 3869' from DER, 111' left of centerline, 99' AGL/467' MSL.

Tree 4618' from DER, 1693' left of centerline, 125' AGL/493' MSL.

Trees beginning 4711' from DER, 1430' left of centerline, up to 132' AGL/501' MSL.

Rwy 19, bush 82' from DER, 272' right of centerline, 358' MSL.

Wsk 100' from DER, 207' right of centerline, 11' AGL/361' MSL.

Tree 125' from DER, 500' left of centerline, 23' AGL/374' MSL.

Tree 130' from DER, 499' right of centerline, 63' AGL/412' MSL.

Trees beginning 173' from DER, 145' left of centerline, up to 50' AGL/401' MSL.

Tree, pole beginning 266' from DER, 170' right of centerline, up to 75' AGL/425' MSL.

Trees beginning 1345' from DER, 167' right of centerline, up to 83' AGL/432' MSL.

Tree 1648' from DER, 912' left of centerline, 54' AGL/403' MSL.

Trees beginning 1692' from DER, 67' right of centerline, up to 85' AGL/434' MSL.

Trees beginning 1816' from DER, 14' left of centerline, up to 68' AGL/416' MSL.

Trees beginning 1948' from DER, 36' left of centerline, up to 71' AGL/419' MSL.

Trees beginning 2008' from DER, 350' right of centerline, up to 96' AGL/440' MSL.

Trees beginning 2064' from DER, 789' left of centerline, up to 90' AGL/485' MSL.

Trees beginning 2376' from DER, 774' left of centerline, up to 76' AGL/520' MSL.

Trees beginning 2481' from DER, 776' left of centerline, up to 80' AGL/527' MSL.

Trees beginning 2485' from DER, 199' right of centerline, up to 101' AGL/449' MSL.

Trees beginning 2500' from DER, 193' right of centerline, up to 107' AGL/453' MSL.

Trees beginning 3009' from DER, 684' left of centerline, up to 77' AGL/535' MSL.

Trees beginning 3062' from DER, 761' left of centerline, up to 83' AGL/542' MSL.

Trees beginning 3168' from DER, 755' left of centerline, up to 94' AGL/549' MSL.

Trees beginning 6019' from DER, 1486' left of centerline, up to 80' AGL/556' MSL.

Trees beginning 1 NM from DER, 1624' left of centerline, up to 82' AGL/558' MSL.

Tree, road (north), fence, terrain, antenna, satellite dish, light pole, building, VOR/DME beginning 1 NM from DER, 1382' left of centerline, up to 77' AGL/595' MSL.

Tree, fence beginning 1.1 NM from DER, 1379' left of centerline, up to 70' AGL/600' MSL.

Tree, fence beginning 1.1 NM from DER, 1338' left of centerline, up to 78' AGL/602' MSL.

Tree 1.3 NM from DER, 1920' left of centerline, 90' AGL/575' MSL.

25 JAN 2024 to 21 MAR 2024

25 JAN 2024 to 21 MAR 2024

TAKEOFF MINIMUMS, (OBSTACLE) DEPARTURE PROCEDURES, AND DIVERSE VECTOR AREA (RADAR VECTORS)

24025

AK

TAKEOFF MINIMUMS, (OBSTACLE) DEPARTURE PROCEDURES, AND DIVERSE VECTOR AREA (RADAR VECTORS)

24025

TANANA, AK

RALPH M CALHOUN MEML (TAL) (PATA)

TAKEOFF MINIMUMS AND (OBSTACLE) DEPARTURE PROCEDURES

AMDT 1A 08NOV18 (21112) (FAA)

TAKEOFF MINIMUMS:

Rwy 7, std. w/min. climb of 405' per NM to 1300, or 1200-3 for VCOA.

Rwy 25, 300-1% or std. w/min. climb of 256' per NM to 600.

DEPARTURE PROCEDURE:

Rwy 7, climbing right turn on heading 102° and TAL VOR/DME R-081 to SATUE/TAL 12.00 DME.

Rwy 25, climbing left turn on heading 078° and TAL VOR/DME R-081 to SATUE.

All aircraft continue climb in SATUE/12.00 DME holding pattern (hold east, left turn, 261° inbound) to cross SATUE at or above 4000 before proceeding on course.

VCOA:

Rwy 7, obtain ATC approval for VCOA when requesting IFR clearance. Climb in visual conditions to cross Ralph M Calhoun Meml airport at or above 1300 then climb on TAL VOR/DME R-081 to SATUE, continue climb in SATUE holding pattern (hold east, left turn, 261° inbound) to cross SATUE at or above 4000 before proceeding on course.

TAKEOFF OBSTACLE NOTES:

Rwy 7, NAVAID 10' from DER, 60' left of centerline, 2' AGL/243' MSL.

Vegetation 21' from DER, 194' left of centerline, 9' AGL/244' MSL.

Tree 25' from DER, 422' right of centerline, 47' AGL/276' MSL.

Trees, vegetation beginning 83' from DER, 249' left of centerline, up to 26' AGL/260' MSL.

Trees beginning 117' from DER, 360' right of centerline, up to 52' AGL/280' MSL.

Tree 193' from DER, 513' left of centerline, 30' AGL/266' MSL.

Tree 373' from DER, 520' left of centerline, 32' AGL/267' MSL.

Trees beginning 460' from DER, 511' left of centerline, up to 32' AGL/268' MSL.

Trees beginning 1.4 NM from DER, 2394' left of centerline, up to 79' AGL/481' MSL.

Trees beginning 1.6 NM from DER, 2194' left of centerline, up to 89' AGL/587' MSL.

Trees beginning 1.6 NM from DER, 2360' left of centerline, up to 89' AGL/620' MSL.

Trees beginning 1.7 NM from DER, 1974' left of centerline, up to 85' AGL/658' MSL.

Trees beginning 1.8 NM from DER, 1989' left of centerline, up to 99' AGL/722' MSL.

Trees beginning 2 NM from DER, 1467' left of centerline, up to 95' AGL/806' MSL.

Trees beginning 2.1 NM from DER, 1470' left of centerline, up to 77' AGL/772' MSL.

Trees beginning 2.3 NM from DER, 1489' left of centerline, up to 93' AGL/856' MSL.

Tree, vehicles on road beginning 2.3 NM from DER, 1930' left of centerline, up to 88' AGL/868' MSL.

Tree, vehicles on road beginning 2.4 NM from DER, 1491' left of centerline, up to 61' AGL/853' MSL.

Tree, vehicles on road, vertical structure beginning 2.4 NM from DER, 1494' left of centerline, up to 60' AGL/869' MSL.

Rwy 25, building 5' from DER, 371' left of centerline, 10' AGL/232' MSL.

Tree 8' from DER, 343' left of centerline, 10' AGL/233' MSL.

Trees, NAVAID beginning 8' from DER, 59' left of centerline, up to 10' AGL/234' MSL.

NAVAID 9' from DER, 60' right of centerline, 2' AGL/231' MSL.

Trees beginning 224' from DER, 493' right of centerline, up to 44' AGL/273' MSL.

Trees, vehicles on road beginning 908' from DER, 573' right of centerline, up to 44' AGL/281' MSL.

Trees beginning 1911' from DER, 421' right of centerline, up to 39' AGL/282' MSL.

Trees beginning 2341' from DER, 559' right of centerline, up to 46' AGL/295' MSL.

Trees beginning 2934' from DER, 821' right of centerline, up to 62' AGL/324' MSL.

Trees beginning 3334' from DER, 922' right of centerline, up to 64' AGL/335' MSL.

Trees beginning 3621' from DER, 1057' right of centerline, up to 74' AGL/365' MSL.

Trees beginning 4086' from DER, 1156' right of centerline, up to 76' AGL/368' MSL.

Trees, catenary beginning 5357' from DER, 1369' right of centerline, up to 62' AGL/373' MSL.

Trees beginning 5763' from DER, 1764' right of centerline, up to 58' AGL/410' MSL.

Trees, catenary, pole beginning 5888' from DER, 1389' right of centerline, up to 65' AGL/418' MSL.

Tree, catenary, pole beginning 1 NM from DER, 1381' right of centerline, up to 60' AGL/427' MSL.

Trees beginning 1 NM from DER, 1301' right of centerline, up to 53' AGL/436' MSL.

Trees beginning 1.1 NM from DER, 1136' right of centerline, up to 48' AGL/425' MSL.

TATALINA LRRS (TLJ) (PATL)

TAKOTNA, AK

TAKEOFF MINIMUMS AND (OBSTACLE) DEPARTURE PROCEDURES

ORIG 19MAY22 (22139) (USAF)

DEPARTURE PROCEDURE:

Diverse departures NA.

CAUTION: Uncontrolled airspace below 1200' AGL within 4 NM of Tatalina airport.

Rwy 17, use TATALINA DEPARTURE (RNAV1).

Rwy 35, NA.

TAKEOFF MINIMUMS, (OBSTACLE) DEPARTURE PROCEDURES, AND DIVERSE VECTOR AREA (RADAR VECTORS)

24025

AK

TAKEOFF MINIMUMS, (OBSTACLE) DEPARTURE PROCEDURES, AND DIVERSE VECTOR AREA (RADAR VECTORS)

24025

TATITLEK, AK

TATITLEK (7KA) (PAKA)

TAKEOFF MINIMUMS AND (OBSTACLE) DEPARTURE PROCEDURES

ORIG-A 10JAN13 (13010) (FAA)

TAKEOFF MINIMUMS:

Rwy 13, std. w/min. climb of 358' per NM to 2500 or 3400-2 for climb in visual conditions.

Rwy 31, std. w/min. climb of 370' per NM to 900 or 3400-2 for climb in visual conditions.

DEPARTURE PROCEDURE:

Rwy 13, climbing right turn heading 146° and JOH R-338 to JOH VOR/DME before proceeding on course or ...

Rwy 31, climbing left turn heading 252° to intercept JOH R-316 to JOH VOR/DME before proceeding on course. Do not

exceed 180 KIAS until established on JOH R-316 or ...
Rwys 13, 31, ... for climb in visual conditions: cross Tatitlek airport at or above 3300 then via JOH R-336 to JOH VOR/DME before proceeding on course. Do not exceed 180 KIAS until established on JOH R-336 to JOH VOR/DME.

Note: rapidly rising terrain northwest of procedure.

TAKEOFF OBSTACLE NOTES:

Rwy 13, trees 335' from DER, 411' right of centerline, 39' AGL/79' MSL.

Trees 11' from DER, 467' left of centerline, 34' AGL/74' MSL.

Bush 429' from DER, 48' right of centerline, 12' AGL/52' MSL.

Vent on building 1172' from DER, 767' left of centerline, 58' AGL/98' MSL.

Pole 3072' from DER, 194' left of centerline, 99' AGL/139' MSL.

Rwy 31, trees beginning 23' from DER, 339' right of centerline, up to 100' AGL/703' MSL.

TELLER, AK

TELLER (TER) (PATE)

TAKEOFF MINIMUMS AND (OBSTACLE) DEPARTURE PROCEDURES

AMDT 1 16JUL20 (20198) (FAA)

TAKEOFF MINIMUMS:

Rwy 8, std. w/min. climb of 320' per NM to 1700, or 1600-3 for VCOA.

Rwy 26, 400-3 or std. w/min. climb of 230' per NM to 600.

DEPARTURE PROCEDURE:

Rwy 8, climb on heading 080° to 1700 before turning right.

Rwy 26, climb on heading 260° to 1200 before turning left.

VCOA:

Rwy 8, obtain ATC approval for VCOA when requesting IFR clearance. Climb in visual conditions to cross Teller airport at or above 1600 before proceeding on course.

TAKEOFF OBSTACLE NOTES:

Rwy 8, wind indicator 18' from DER, 377' left of centerline, 20' AGL/317' MSL.

Pole 264' from DER, 498' left of centerline, 34' AGL/332' MSL.

Vertical structure 298' from DER, 476' left of centerline, 34' AGL/333' MSL.

Antenna, poles beginning 303' from DER, 483' left of centerline, up to 56' AGL/355' MSL.

Rwy 26, lights beginning 8' from DER, 21' right of centerline, up to 2' AGL/282' MSL.

Light 9' from DER, 29' left of centerline, 2' AGL/282' MSL.

TIN CITY LRRS (TNC) (PATC)

TIN CITY, AK

TAKEOFF MINIMUMS AND (OBSTACLE) DEPARTURE PROCEDURES

AMDT 1 15JUN23 (23166) (USAF)

TAKEOFF MINIMUMS:

Rwy 34, std. w/min. climb 357' per NM to 800 for JEKLI DEPARTURE. 2500-3 for climb in visual conditions.

DEPARTURE PROCEDURE:

Diverse departures NA.

Rwy 16, use HONPO DEPARTURE.

Rwy 34, use JEKLI DEPARTURE.

VCOA:

Rwy 34, obtain ATC approval for VCOA when requesting IFR clearance. Climb in visual conditions to cross Tin City LRRS airport at or above 2600 before proceeding on course. Remain within 3 NM of Tin City LRRS airport during climb in visual conditions.

TAKEOFF OBSTACLE NOTES:

Rwy 16, no takeoff obstacles.

Rwy 34, terrain at DER, 500' right of centerline, 265' MSL.

Terrain 3925' from DER, 1056' left of centerline, 394' MSL.

Terrain 4228' from DER, 1027' left of centerline, 407' MSL.

Terrain 4835' from DER, 970' left of centerline, 407' MSL.

TAKEOFF MINIMUMS, (OBSTACLE) DEPARTURE PROCEDURES, AND DIVERSE VECTOR AREA (RADAR VECTORS)

24025

AK

TAKEOFF MINIMUMS, (OBSTACLE) DEPARTURE PROCEDURES, AND DIVERSE VECTOR AREA (RADAR VECTORS)

24025

TOGIAK VILLAGE, AK

TOGIAK (TOG) (PATG)

TAKEOFF MINIMUMS AND (OBSTACLE) DEPARTURE PROCEDURES

AMDT 2 24MAY18 (18144) (FAA)

TAKEOFF MINIMUMS:

Rwys 10, 28, NA-Environmental.

Rwy 3, std. w/ min. climb of 215' per NM to 3600, or 2000-3 for VCOA.

DEPARTURE PROCEDURE:

Rwy 3, climb on a heading between 030° CW 210° from DER, or min. climb of 315' per NM to 3100 for headings from 211° CW 029°.

Rwy 21, climb heading 210° to 1600 before proceeding on course.

VCOA:

Rwy 3, obtain ATC approval for VCOA when requesting IFR clearance. Climb in visual conditions to cross Togiak airport at or above 1900 before proceeding on course.

TAKEOFF OBSTACLE NOTES:

Rwy 3, vegetation and building beginning 7' from DER, 165' right and 80' left of centerline, 7' AGL/21' MSL.

Building and vegetation beginning 11' from DER, 85' right and 121' left of centerline, up to 8' AGL/22' MSL.

Buildings and vertical structure, beginning 332' from DER, 498' right of centerline, up to 27' AGL/39' MSL.

Poles, vertical structure, and catenaries beginning 697' from DER, 412' right of centerline, up to 33' AGL/45' MSL.

Poles, beginning 1002' from DER, 473' right of centerline, up to 33' AGL/46' MSL.

Pole 1155' from DER, 591' right of centerline, 35' AGL/48' MSL.

Antenna 1199' from DER, 605' right of centerline, 38' AGL/50' MSL.

Rwy 21, vehicles on road, buildings, and vegetation beginning 9' from DER, 85' left and 100' right of centerline, up to 8' AGL/33' MSL.

Wind indicator 289' from DER, 248' right of centerline, 21' AGL/38' MSL.

Boats beginning 500' from DER, 500' left of centerline, 80' MSL.

TOK, AK

TOK JUNCTION (6K8) (PFTO)

TAKEOFF MINIMUMS AND (OBSTACLE) DEPARTURE PROCEDURES

AMDT 2 05OCT23 (23278) (FAA)

DEPARTURE PROCEDURE:

Use GULKANA (RNAV) DEPARTURE.

TAKEOFF OBSTACLE NOTES:

Rwy 8, building 1' from DER, 384' left of centerline, 11' AGL/1652' MSL.

Vertical structure, vehicle on road beginning 14' from DER, 390' left of centerline, up to 17' AGL/1658' MSL.

Tree 46' from DER, 321' left of centerline, 28' AGL/1668' MSL.

Pole, trees, vegetation, vehicles on road, buildings, vertical structure beginning 48' from DER, 172' left of centerline, up to 41' AGL/1681' MSL.

Trees beginning 65' from DER, 316' right of centerline, up to 56' AGL/1699' MSL.

Trees beginning 201' from DER, 249' left of centerline, up to 44' AGL/1684' MSL.

Trees beginning 487' from DER, 167' right of centerline, up to 56' AGL/1700' MSL.

Trees beginning 774' from DER, 4' left of centerline, up to 45' AGL/1686' MSL.

Rwy 26, buildings beginning 16' from DER, 328' right of centerline, up to 16' AGL/1658' MSL.

Vertical structure, vegetation beginning 18' from DER, 193' right of centerline, up to 21' AGL/1663' MSL.

Tree, buildings, pole, antenna beginning 29' from DER, 391' right of centerline, up to 61' AGL/1702' MSL.

Tree 55' from DER, 504' left of centerline, 60' AGL/1705' MSL.

Trees, vehicles on road beginning 58' from DER, 297' left of centerline, up to 62' AGL/1706' MSL.

Tree, building beginning 134' from DER, 382' right of centerline, up to 62' AGL/1703' MSL.

Trees, buildings, vertical structure, vehicles on road, poles beginning 148' from DER, 68' right of centerline, up to 64' AGL/1705' MSL.

Trees beginning 937' from DER, 397' left of centerline, up to 62' AGL/1708' MSL.

Trees beginning 1119' from DER, 230' left of centerline, up to 64' AGL/1709' MSL.

Trees beginning 1523' from DER, 59' left of centerline, up to 72' AGL/1717' MSL.

Trees beginning 2001' from DER, 25' right of centerline, up to 66' AGL/1707' MSL.

Trees beginning 2043' from DER, 117' left of centerline, up to 75' AGL/1718' MSL.

Trees beginning 2417' from DER, 2' right of centerline, up to 72' AGL/1711' MSL.

TOKSOOK BAY, AK

TOKSOOK BAY (OOK) (PAOO)

TAKEOFF MINIMUMS AND (OBSTACLE) DEPARTURE PROCEDURES

AMDT 1A 22AUG13 (13234) (FAA)

TAKEOFF MINIMUMS:

Rwy 34, std. w/min. climb of 481' per NM to 1700, or 1600-2½ for climb in visual conditions.

DEPARTURE PROCEDURE:

Rwy 16, climb heading 165° to 1000 before proceeding on course.

Rwy 34, for climb in visual conditions: Cross Toksook Bay Airport at or above 1500' MSL before proceeding on course. When executing VCOA notify ATC prior to departure.

TAKEOFF OBSTACLE NOTES:

Rwy 16, multiple lights beginning at DER, 40' left of centerline, up to 4' AGL/51' MSL.

Light 4' from DER, 78' right of centerline 2' AGL/52' MSL.

Lights 50' from DER, 356' right of centerline, 34' AGL/84' MSL.

Rwy 34, multiple lights beginning at DER, 39' left of centerline, up to 3' AGL/74' MSL.

Multiple lights beginning at DER, 39' right of centerline, up to 3' AGL/74' MSL.

TAKEOFF MINIMUMS, (OBSTACLE) DEPARTURE PROCEDURES, AND DIVERSE VECTOR AREA (RADAR VECTORS)

24025

AK

**TAKEOFF MINIMUMS, (OBSTACLE) DEPARTURE PROCEDURES, AND
DIVERSE VECTOR AREA (RADAR VECTORS)**

24025

UNALAKLEET, AK

UNALAKLEET (UNK) (PAUN)

TAKEOFF MINIMUMS AND (OBSTACLE) DEPARTURE PROCEDURES

AMDT 2 24MAY18 (18144) (FAA)

DEPARTURE PROCEDURE:

Use UNALAKLEET DEPARTURE.

UNALASKA, AK

UNALASKA (DUT) (PADU)

TAKEOFF MINIMUMS AND (OBSTACLE) DEPARTURE PROCEDURES

AMDT 5 21JUL16 (16203) (FAA)

TAKEOFF MINIMUMS:

Rwy 13, 1000-3. NA at night-obstacles.**Rwy 31**, 600-2.

DEPARTURE PROCEDURE:

Rwys 13, 31, climb in visual conditions until established on DUT NDB/DME 360° bearing over JADPI/DUT 2 DME (visual conditions must be maintained from TAKEOFF until established over JADPI at or above 400). Cross JADPI at or above 400 then climb on the 360° bearing from DUT NDB/DME to 5500 before proceeding on course.

TAKEOFF OBSTACLE NOTES:

Rapidly rising terrain to above 2000' MSL east, south, and west of airport.

UTQIAGVIK, AK

WILEY POST-WILL ROGERS MEML (BRW) (PABR)

TAKEOFF MINIMUMS AND (OBSTACLE) DEPARTURE PROCEDURES

ORIG-C 02DEC21 (21336) (FAA)

TAKEOFF OBSTACLE NOTES:

Rwy 8, NAVAID beginning 8' from DER, 81' right of centerline, up to 1' AGL/38' MSL.

NAVAID beginning 8' from DER, 50' left of centerline, up to 1' AGL/38' MSL.

NAVAID 243' from DER, on centerline, 32' AGL/46' MSL.

Rwy 26, fence, NAVAID beginning abeam DER, 60' left of centerline, up to 6' AGL/51' MSL.

NAVAID beginning 7' from DER, 51' right of centerline, up to 1' AGL/49' MSL.

Vehicle on road beginning 57' from DER, 444' left of centerline, up to 54' MSL.

Sign 325' from DER, 268' right of centerline, 49' AGL/59' MSL.

Poles beginning 468' from DER, 552' right of centerline, up to 62' AGL/72' MSL.

VALDEZ, AK

VALDEZ PIONEER FLD (VDZ) (PAVD)

TAKEOFF MINIMUMS AND (OBSTACLE) DEPARTURE PROCEDURES

AMDT 6 09FEB12 (21224) (FAA)

DEPARTURE PROCEDURE:

Rwys 6, 24, use JMAAL DEPARTURE.**VENETIE, AK**

VENETIE (VEE) (PAVE)

TAKEOFF MINIMUMS AND (OBSTACLE) DEPARTURE PROCEDURES

AMDT 1 17JUN21 (21168) (FAA)

DEPARTURE PROCEDURE:

Use VENETIE (RNAV) DEPARTURE.

WAINWRIGHT, AK

WAINWRIGHT (AWI) (PAWI)

TAKEOFF MINIMUMS AND (OBSTACLE) DEPARTURE PROCEDURES

AMDT 1 20JUN19 (19171) (FAA)

TAKEOFF OBSTACLE NOTES:

Rwy 24, fence 281' from DER, 521' right of centerline, 8' AGL/50' MSL.

Pole, antenna, catenary beginning 1368' from DER, 795' right of centerline, up to 43' AGL/95' MSL.

Tower, antenna beginning 1962' from DER, 895' right of centerline, up to 94' AGL/135' MSL.

25 JAN 2024 to 21 MAR 2024

25 JAN 2024 to 21 MAR 2024

**TAKEOFF MINIMUMS, (OBSTACLE) DEPARTURE PROCEDURES, AND
DIVERSE VECTOR AREA (RADAR VECTORS)**

24025

AK

**TAKEOFF MINIMUMS, (OBSTACLE) DEPARTURE PROCEDURES, AND
DIVERSE VECTOR AREA (RADAR VECTORS)**

24025

WALES, AK

WALES (IWK) (PAIW)

TAKEOFF MINIMUMS AND (OBSTACLE) DEPARTURE PROCEDURES

AMDT 1 08NOV18 (18312) (FAA)

TAKEOFF MINIMUMS:

Rwy 18, 400-1½, or std. w/min. climb of 445' per NM to 600.

DEPARTURE PROCEDURE:

Rwy 36, climb on heading 001° to 2000 then turn right heading 187° to intercept the 153° course to TNC NDB/DME.**Rwy 18**, climb on heading 181° until crossing TNC NDB/DME bearing 228° then turn left heading 022° to intercept the 048° course to TNC NDB/DME.

TAKEOFF OBSTACLE NOTES:

Rwy 18, tree, 1.1 NM from DER, 2334' left of centerline, 349' MSL.**WASILLA, AK**

WASILLA (IYS) (PAWS)

TAKEOFF MINIMUMS AND (OBSTACLE) DEPARTURE PROCEDURES

AMDT 2B 20JUN19 (19171) (FAA)

TAKEOFF MINIMUMS:

Rwy 4S, 22S, NA - Environmental

DEPARTURE PROCEDURE:

Rwy 4, climbing left turn direct BGQ VORTAC. Do not exceed 180K until passing BGQ VORTAC, thence...**Rwy 22**, climbing right turn direct BGQ VORTAC, thence...

...aircraft departing BGQ VORTAC on radials 161° CW 336° climb on course. All other aircraft climb in holding pattern (hold north, right turn, 175° inbound) to cross BGQ VORTAC at or above appropriate MCA before proceeding on course.

TAKEOFF OBSTACLE NOTES:

Rwy 4, trees beginning 150' from DER, left and right of centerline, up to 60' AGL/504' MSL.**Rwy 22**, trees beginning 9' from DER, left and right of centerline, up to 60' AGL/470' MSL.**WHITE MOUNTAIN, AK**

WHITE MOUNTAIN (WMO) (PAWM)

TAKEOFF MINIMUMS AND (OBSTACLE) DEPARTURE PROCEDURES

ORIG 12DEC13 (13346) (FAA)

TAKEOFF MINIMUMS:

Rwy 33, std. w/min. climb of 275' per NM to 1000 or 1000-2½ for climb in visual conditions.

DEPARTURE PROCEDURE:

Rwy 33, climb heading 332° to 800 before turning right or for climb in visual conditions, cross White Mountain airport at or above 1100 before proceeding on course. When executing VCOA, notify ATC prior to departure.

TAKEOFF OBSTACLE NOTES:

Rwy 15, cross 134' from DER, 323' left of centerline, 23' AGL/273' MSL.**Rwy 33**, trees beginning 32' from DER, 321' left of centerline, up to 55' AGL/255' MSL.**WILLOW, AK**

WILLOW (UJO) (PAUO)

TAKEOFF MINIMUMS AND (OBSTACLE) DEPARTURE PROCEDURES

ORIG 28SEP06 (06271) (FAA)

DEPARTURE PROCEDURE:

Use BIG LAKE DEPARTURE.

WRANGELL, AK

WRANGELL (WRG) (PAWG)

TAKEOFF MINIMUMS AND (OBSTACLE) DEPARTURE PROCEDURES

AMDT 2 25AUG11 (11237) (FAA)

DEPARTURE PROCEDURE:

Rwys 10, 28, use LEVEL ISLAND DEPARTURE.

25 JAN 2024 to 21 MAR 2024

25 JAN 2024 to 21 MAR 2024

**TAKEOFF MINIMUMS, (OBSTACLE) DEPARTURE PROCEDURES, AND
DIVERSE VECTOR AREA (RADAR VECTORS)**

24025

AK

TAKEOFF MINIMUMS, (OBSTACLE) DEPARTURE PROCEDURES, AND

DIVERSE VECTOR AREA (RADAR VECTORS)

24025

YAKUTAT, AK**YAKUTAT (YAK) (PAYA)**

TAKEOFF MINIMUMS AND (OBSTACLE) DEPARTURE PROCEDURES

AMDT 5A 29MAY14 (14149) (FAA)

DEPARTURE PROCEDURE:

Rwys 2, 11, 20, 29, all aircraft climb to airway MEA for direction of flight direct YAK VOR/DME or OCC NDB, continue climb to MEA via assigned airway.

TAKEOFF OBSTACLE NOTES:

Rwy 2, trees, obstruction light on TACAN monitor, tower beginning 372' from DER, 237' left of centerline, up to 89' AGL/114' MSL.

Trees beginning 457' from DER 317' right of centerline up to 74' AGL/99' MSL.

Tree 4347' from DER, 1617' left of centerline, 148' AGL/167' MSL.

Rwy 11, trees beginning 94' from DER, 344' right of centerline, up to 75' AGL/98' MSL.

Trees beginning 121' from DER, 376' left of centerline, up to 63' AGL/86' MSL.

Trees beginning 1658' from DER, 442' left of centerline, up to 92' AGL/115' MSL.

Rwy 20, tree beginning 78' from DER, 364' left of centerline, up to 67' AGL/181' MSL.

Trees beginning 129' from DER, 471' right of centerline, up to 50' AGL/60' MSL.

Trees beginning 1013' from DER, 283' left of centerline, up to 86' AGL/96' MSL.

Trees beginning 1087' from DER, 340' right of centerline, up to 50' AGL/64' MSL.

Trees beginning 3657' from DER, 497' left of centerline, up to 137' AGL/147' MSL.

Trees beginning 4184' from DER, 296' right of centerline, up to 148' AGL/158' MSL.

Rwy 29, tree 50' from DER, 280' left of centerline, 27' AGL/54' MSL.

Tree 122' from DER, 389' right of centerline, 52' AGL/79' MSL.

Tree 1268' from DER, 696' left of centerline, 42' AGL/69' MSL.

Trees beginning 1676' from DER, 729' right of centerline, up to 90' AGL/120' MSL.

Trees 2675' from DER, 860' left of centerline, up to 108' AGL/138' MSL.

Trees beginning 3303' from DER, 1050' right of centerline, up to 123' AGL/153' MSL.

25 JAN 2024 to 21 MAR 2024

25 JAN 2024 to 21 MAR 2024

TAKEOFF MINIMUMS, (OBSTACLE) DEPARTURE PROCEDURES, AND

DIVERSE VECTOR AREA (RADAR VECTORS)

24025

AK

(KTS3.MUJUD) 23278

AL-10274 (FAA)

BREVIG MISSION (KTS) (PFKT)
BREVIG MISSION, ALASKA

BREVIG THREE DEPARTURE (OBSTACLE) (RNAV)

AWOS-3P
121.55
ANCHORAGE CENTER
133.3 290.4
CTAF
123.0

RNAV1 - GPS

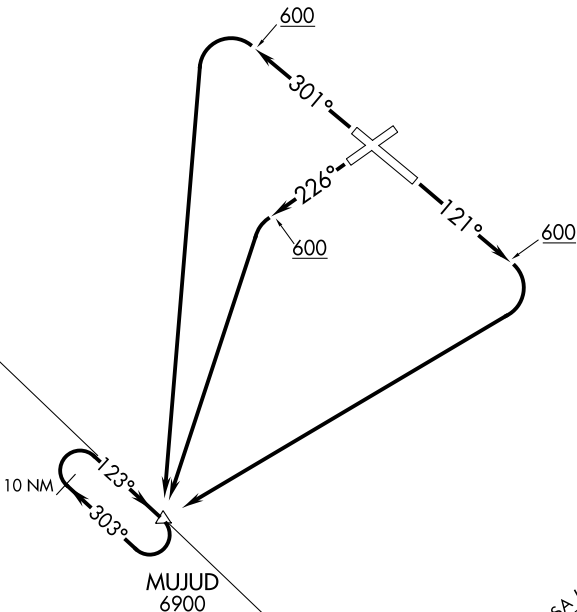

TAKEOFF MINIMUMS

- Rwy 5: NA-Terrain.
- Rwys 12, 23: Standard.
- Rwy 30: 400-2¾ or standard with minimum climb of 237' per NM to 500.

TAKEOFF OBSTACLE NOTES

- Rwy 12: Vegetation 154' from DER, 373' right of centerline, 40' MSL.
Power Line 803' from DER, 632' right of centerline, 34' AGL/62' MSL.
- Rwy 23: Vehicle on road 136' from DER, 440' left of centerline, 14' AGL/53' MSL.
Pole 262' from DER, 543' right of centerline, 45' AGL/60' MSL

NOTE: Chart not to scale.

DEPARTURE ROUTE DESCRIPTION

- TAKEOFF RUNWAY 12: Climb on heading 121° to 600 then climbing right turn direct MUJUD, thence. . . .
- TAKEOFF RUNWAY 23: Climb on heading 226° to 600 then climbing left turn direct MUJUD, thence. . . .
- TAKEOFF RUNWAY 30: Climb on heading 301° to 600 then climbing left turn direct MUJUD, thence. . . .
. . . .continue climb in hold at MUJUD to at or above 6900. Maintain ATC assigned altitude before proceeding on course.

BREVIG THREE DEPARTURE (OBSTACLE) (RNAV)
(KTS3.MUJUD) 05OCT23

BREVIG MISSION, ALASKA
BREVIG MISSION (KTS) (PFKT)

AK, 25 JAN 2024 to 21 MAR 2024

AK, 25 JAN 2024 to 21 MAR 2024